

TQF 25GUUW-E NB

Linear bushing

TYPE: Shaft guidance systems, Linear bushing, Pilot flange location, Circular type, double length, Type TQF..W..E (NB)

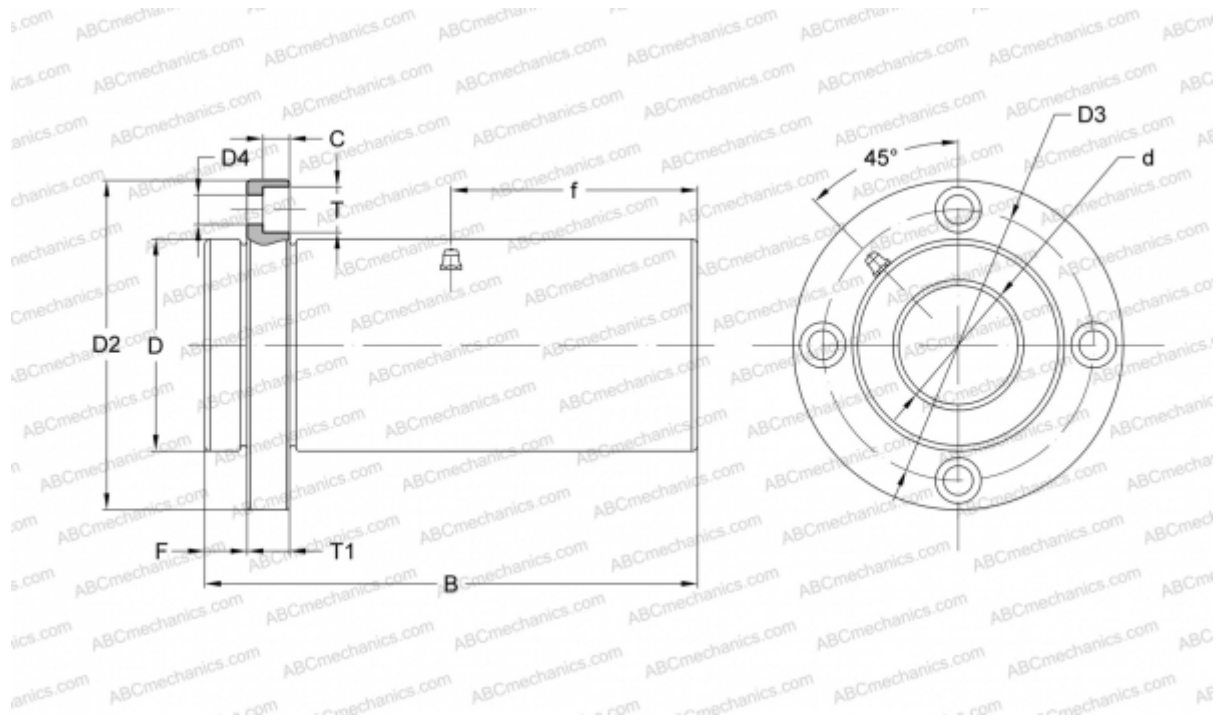

Technical specification

DIMENSIONS, MM

d	25,000
D	45,000
B	112,000
D2	74,000
D3	60,000
D4	6,600
T	11,000
T1	10,000
f	56,000
C	6,100
F	10

MANUFACTURER

[NB](#)