

TQK 20GUU-E NB

Linear bushing

TYPE: Shaft guidance systems, Linear bushing, Pilot flange location, Square type, Type TQK..E (NB)

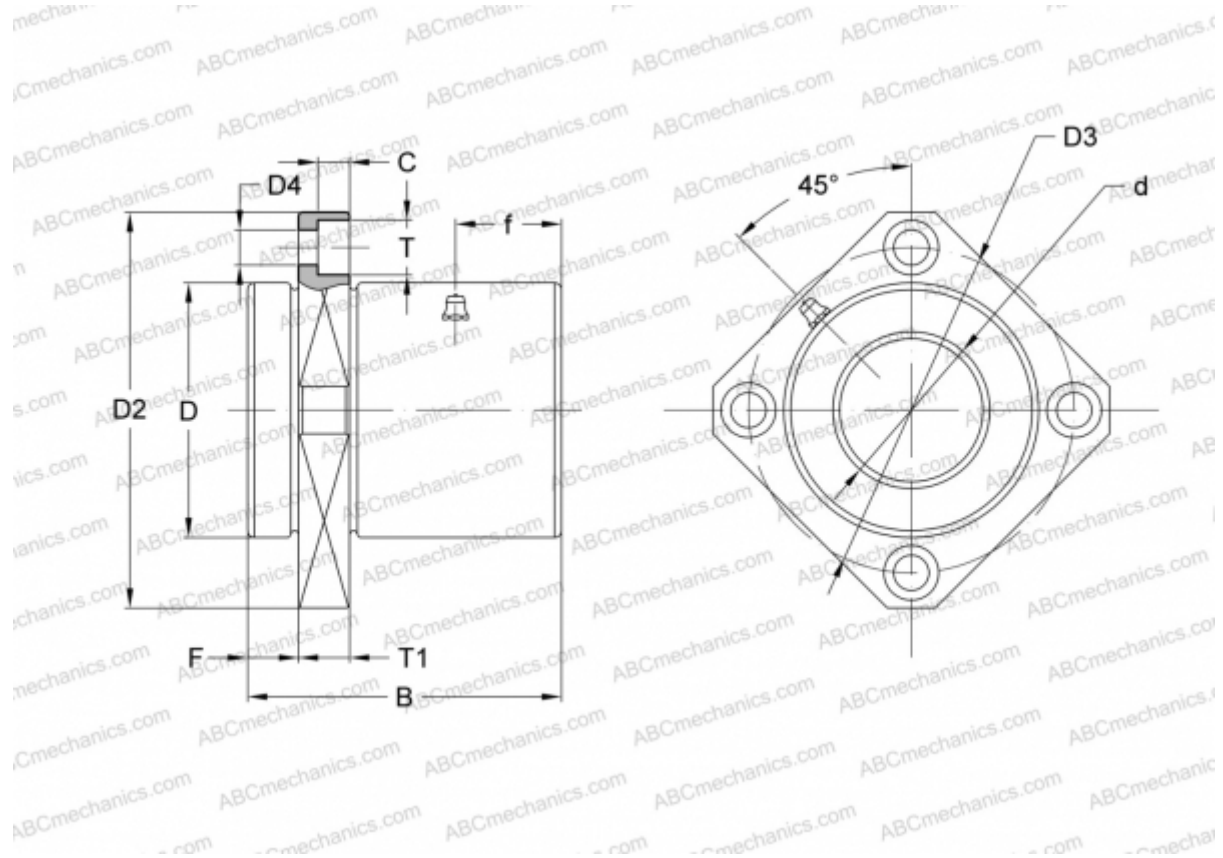

Technical specification

DIMENSIONS, MM

d	20,000
D	40,000
B	42,000
D2	62,000
D3	51,000
D4	5,500
B2	50,000
T	9,000
T1	8,000
f	14,000
C	5,100
F	8

MANUFACTURER

[NB](#)