

TQK 35GUU-E NB

Linear bushing

TYPE: Shaft guidance systems, Linear bushing, Pilot flange location, Square type, Type TQK..E (NB)

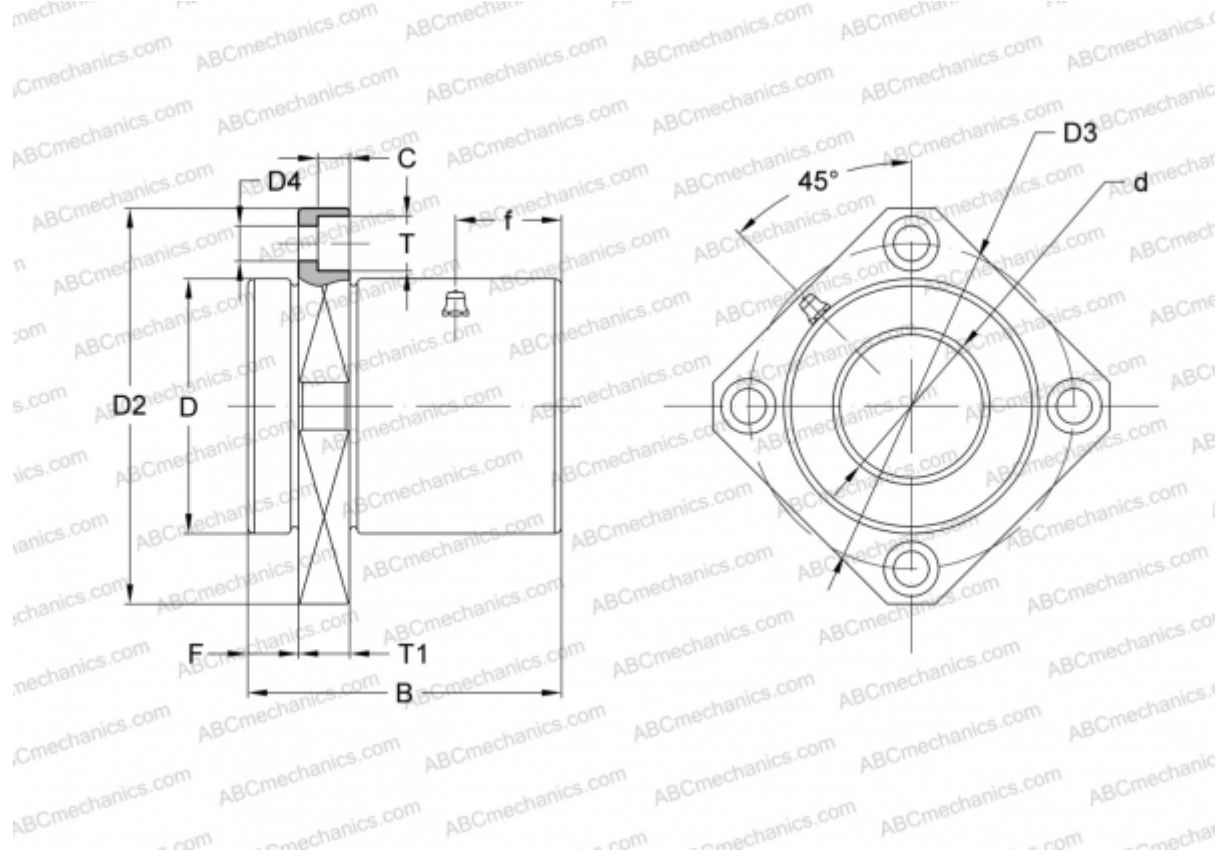

Technical specification

DIMENSIONS, MM

d	35,000
D	60,000
B	70,000
D2	96,000
D3	78,000
D4	9,000
B2	75,000
T	14,000
T1	13,000
f	23,000
C	8,100
F	13

MANUFACTURER

[NB](#)