

TQK 16GUUW-E NB

Linear bushing

TYPE: Shaft guidance systems, Linear bushing, Pilot flange location, Square type, double length, Type TQK..W..E (NB)

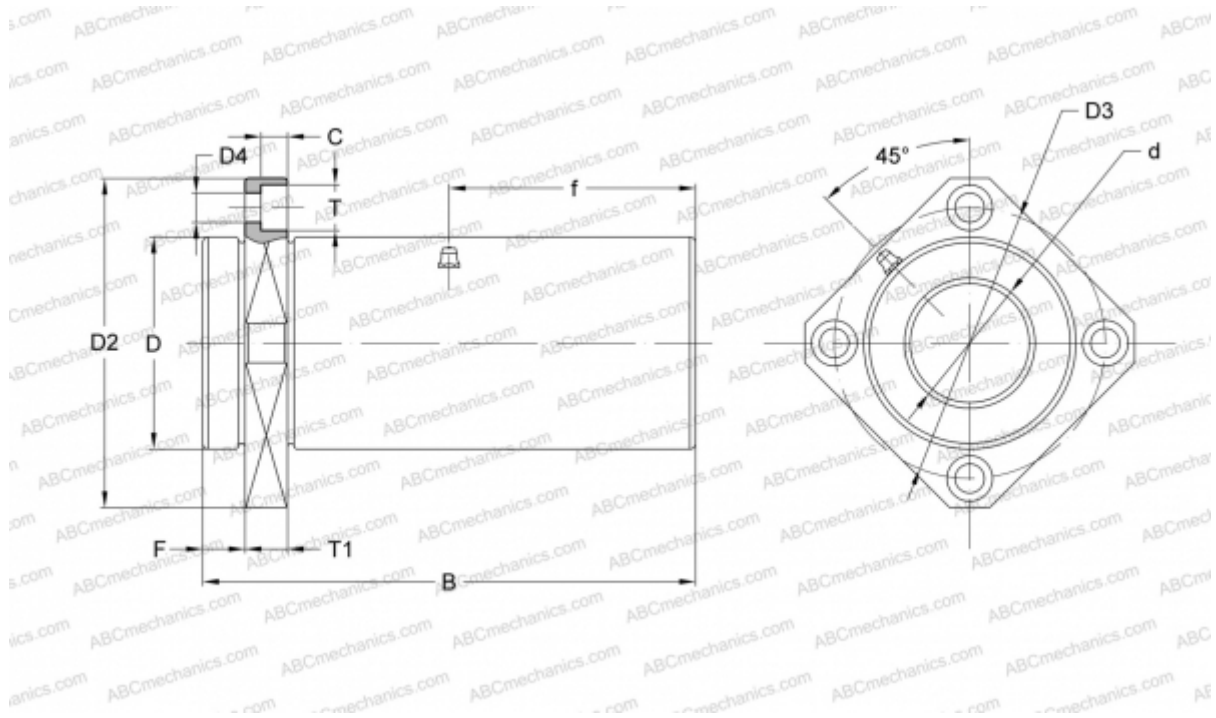

Technical specification

DIMENSIONS, MM

d	16,000
D	32,000
B	70,000
D2	54,000
D3	43,000
D4	5,500
B2	42,000
T	9,000
T1	8,000
f	35,000
C	5,100
F	8

MANUFACTURER

[NB](#)