

TQK 30GUUW-E NB

Linear bushing

TYPE: Shaft guidance systems, Linear bushing, Pilot flange location, Square type, double length, Type TQK..W..E (NB)

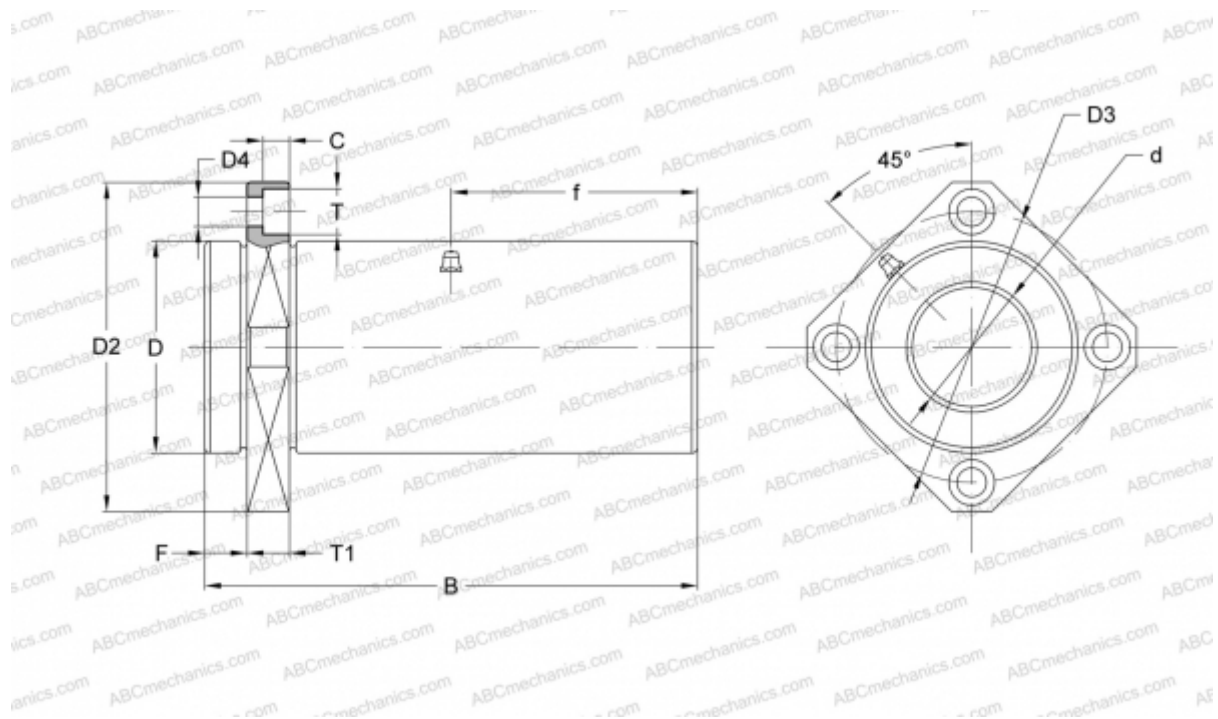

Technical specification

DIMENSIONS, MM

d	30,000
D	52,000
B	123,000
D2	82,000
D3	67,000
D4	6,600
B2	64,000
T	11,000
T1	10,000
f	61,500
C	6,100
F	10

MANUFACTURER

[NB](#)