

TQK 40GUUW-E NB

Linear bushing

TYPE: Shaft guidance systems, Linear bushing, Pilot flange location, Square type, double length, Type TQK..W..E (NB)

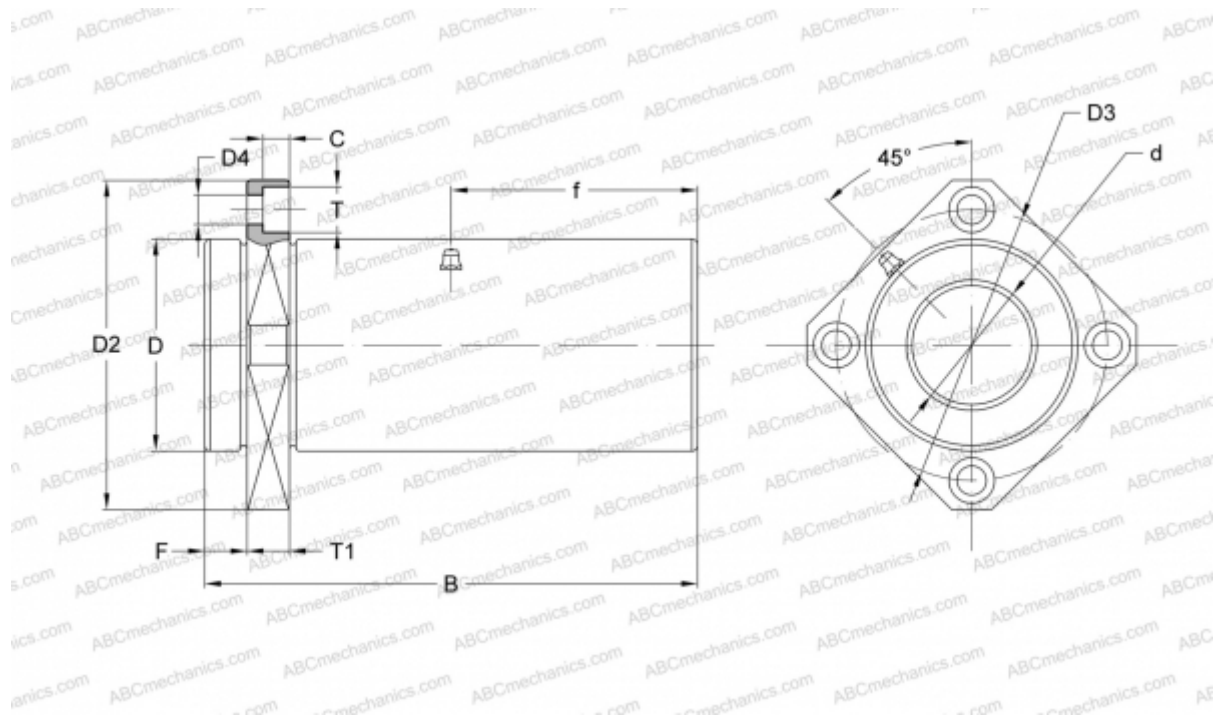

Technical specification

DIMENSIONS, MM

d	40,000
D	65,000
B	151,000
D2	101,000
D3	83,000
D4	9,000
B2	80,000
T	14,000
T1	13,000
f	75,500
C	8,100
F	13

MANUFACTURER [NB](#)