

SMSA 3GUU NB

Linear bushing, case unit

TYPE: Shaft guidance systems, Linear bushing, case unit, Close type, Block type, Type SMA, Corrosion resistance (NB)

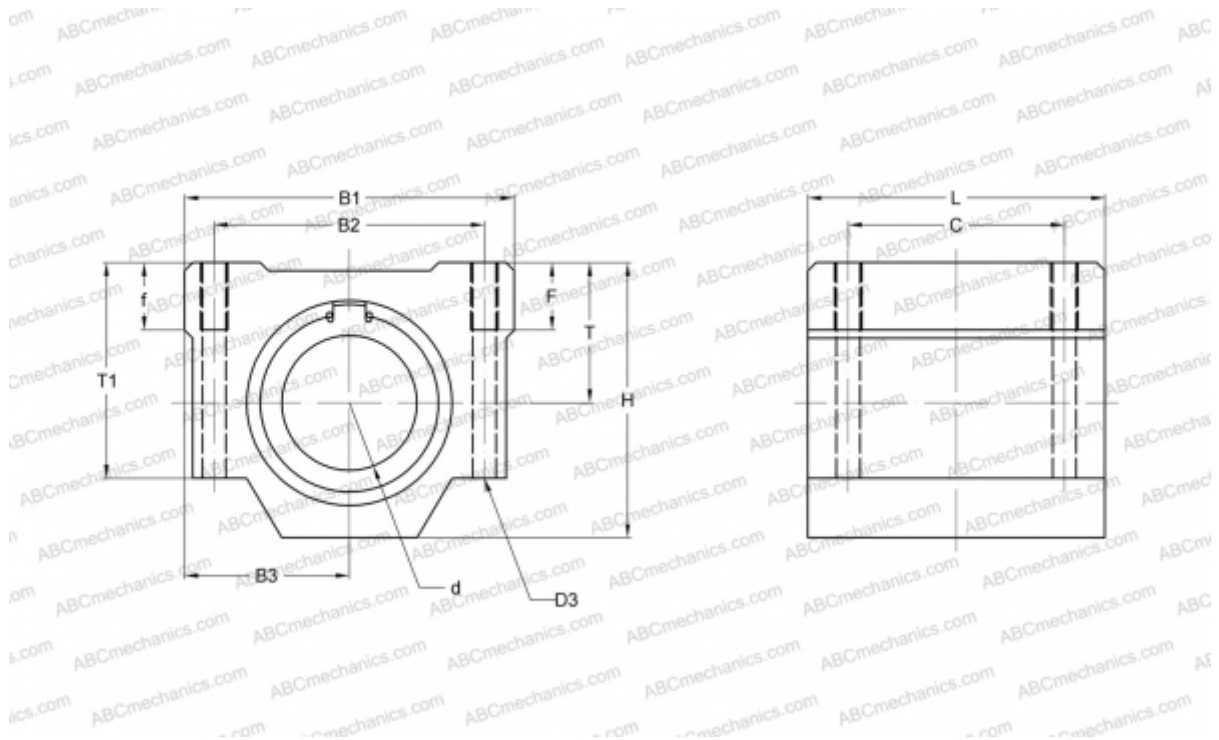

Technical specification

DIMENSIONS, MM

B1	16,000
H	10,000
L	13,000
d	3,000
B2	11,000
B3	8,000
T	5,000
T1	8,000
C	8,000

WEIGHT, KG 0,005

MANUFACTURER [NB](#)