

## SMSA 8GUU NB

Linear bushing, case unit

TYPE: Shaft guidance systems, Linear bushing, case unit, Close type, Block type, Type SMA, Corrosion resistance (NB)

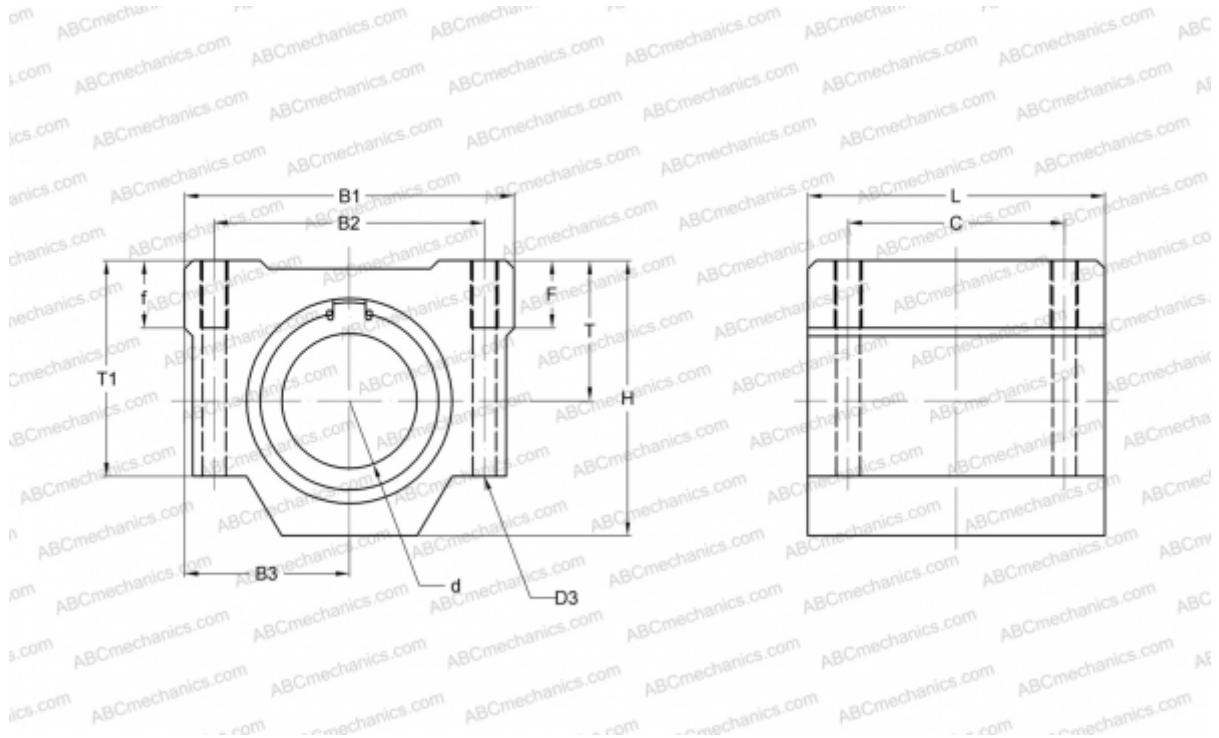

### Technical specification

#### DIMENSIONS, MM

B1	34,000
H	22,000
L	30,000
d	8,000
D3	3,400
B2	24,000
B3	17,000
T	11,000
T1	18,000
f	6,000
C	18,000
F	8

**WEIGHT, KG** 0,052

**MANUFACTURER** [NB](#)