

SMSA13GUU NB

Linear bushing, case unit

TYPE: Shaft guidance systems, Linear bushing, case unit, Close type, Block type, Type SMA, Corrosion resistance (NB)

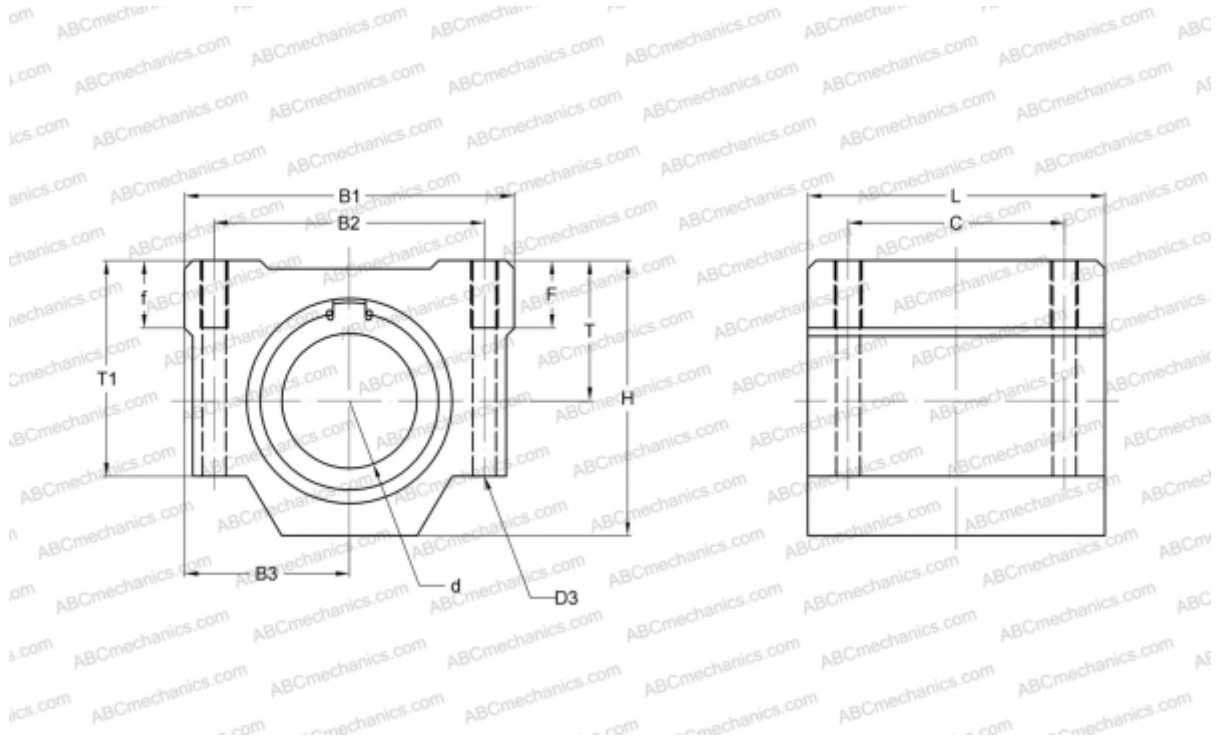

Technical specification

DIMENSIONS, MM

B1	44,000
H	30,000
L	39,000
d	13,000
D3	4,300
B2	33,000
B3	22,000
T	15,000
T1	24,500
f	8,000
C	26,000
F	12

WEIGHT, KG 0,120

MANUFACTURER [NB](#)