

## SMSA16GUU NB

Linear bushing, case unit

TYPE: Shaft guidance systems, Linear bushing, case unit, Close type, Block type, Type SMA, Corrosion resistance (NB)

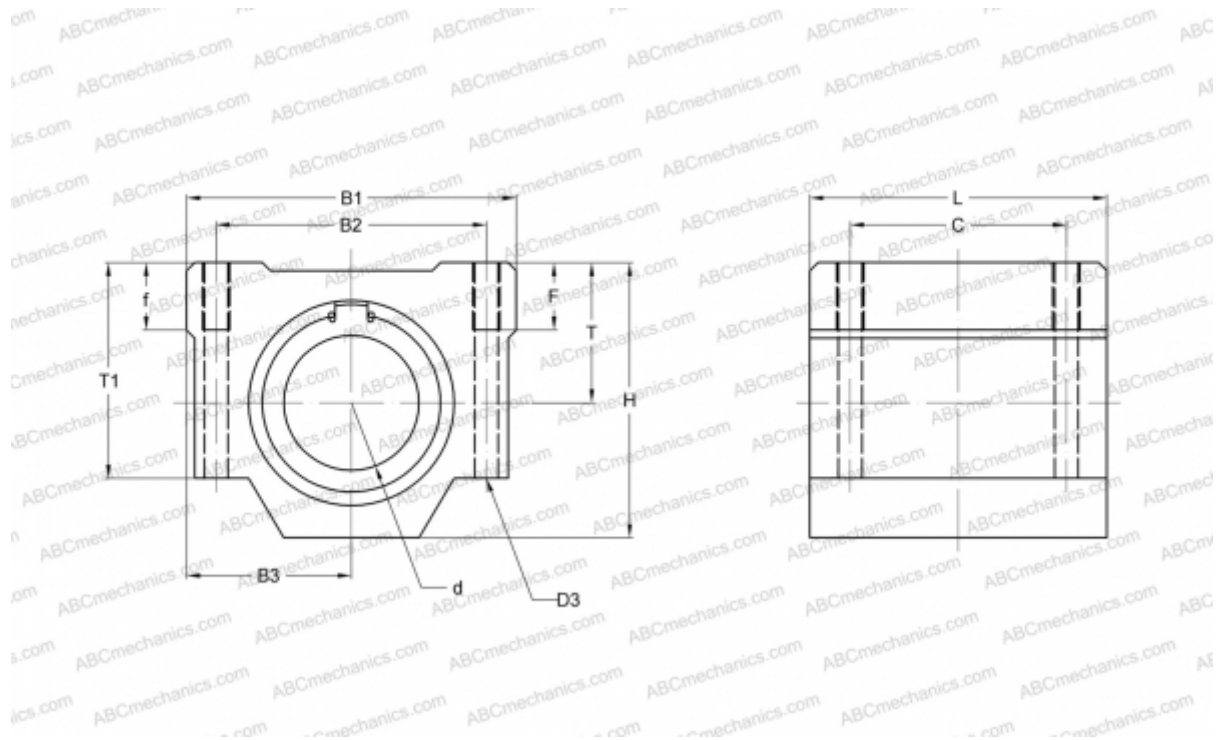

### Technical specification

#### DIMENSIONS, MM

B1	50,000
H	38,500
L	44,000
d	16,000
D3	4,300
B2	36,000
B3	25,000
T	19,000
T1	32,500
f	9,000
C	34,000
F	12

**WEIGHT, KG** 0,200

**MANUFACTURER** [NB](#)