

SMSA20GUU NB

Linear bushing, case unit

TYPE: Shaft guidance systems, Linear bushing, case unit, Close type, Block type, Type SMA, Corrosion resistance (NB)

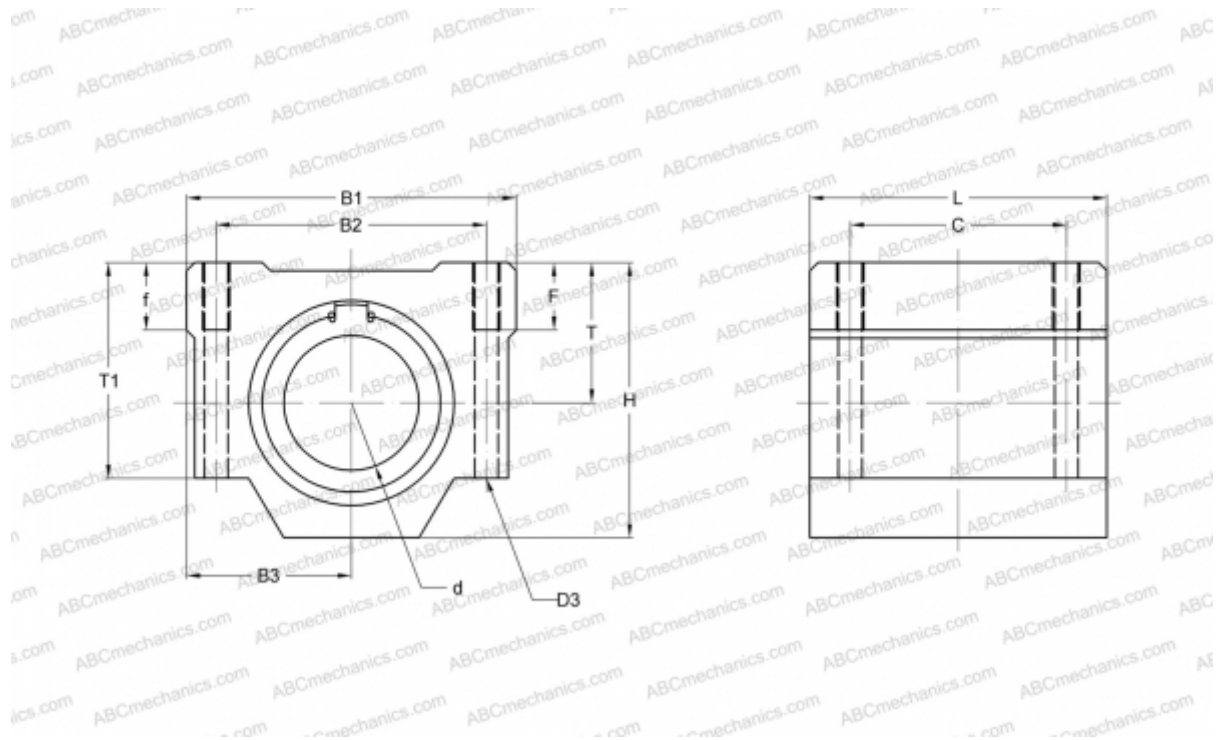

Technical specification

DIMENSIONS, MM

B1	54,000
H	41,000
L	50,000
d	20,000
D3	5,200
B2	40,000
B3	27,000
T	21,000
T1	35,000
f	11,000
C	40,000
F	12

WEIGHT, KG 0,255

MANUFACTURER [NB](#)