

SMSA25GUU NB

Linear bushing, case unit

TYPE: Shaft guidance systems, Linear bushing, case unit, Close type, Block type, Type SMA, Corrosion resistance (NB)

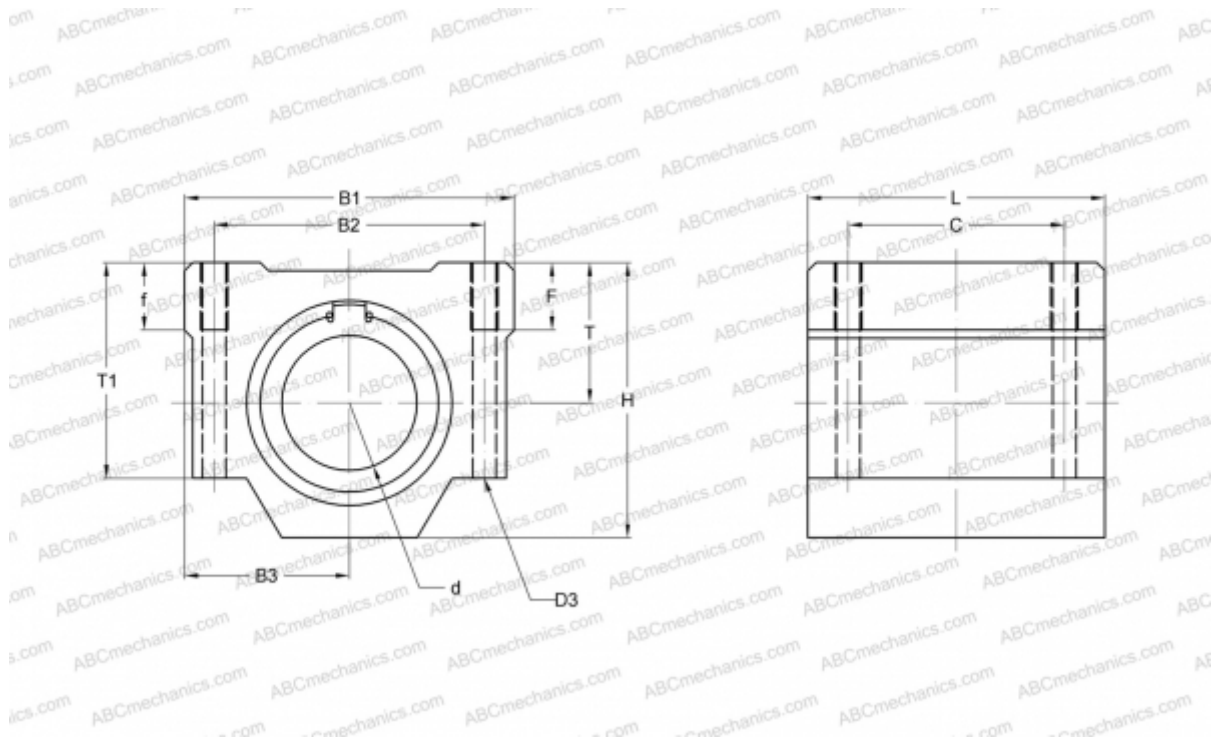

Technical specification

DIMENSIONS, MM

B1	76,000
H	51,500
L	67,000
d	25,000
D3	7,000
B2	54,000
B3	38,000
T	26,000
T1	42,000
f	12,000
C	50,000
F	18

WEIGHT, KG 0,600

MANUFACTURER [NB](#)