

## SWA 16GUU NB

Linear bushing, case unit

TYPE: Shaft guidance systems, Linear bushing, case unit, Close type, Block type, Type SWA, inch size, Standart (NB)

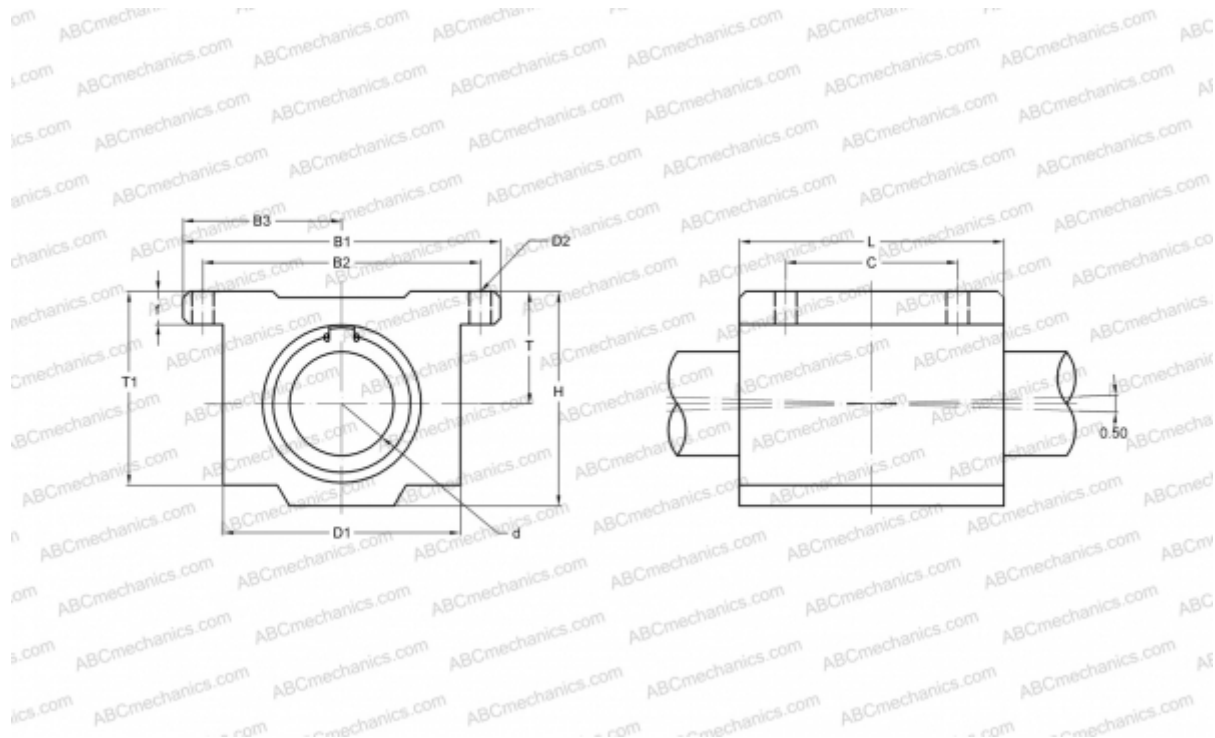

### Technical specification

#### DIMENSIONS, MM

B1	82,550
H	55,560
L	71,440
d	25,400
D1	60,330
D2	5,560
B2	73,030
B3	41,275
T	30,150
T1	49,210
f	9,530
C	44,450

**WEIGHT, KG** 0,615

**MANUFACTURER** [NB](#)