

## SWA 32GUU NB

Linear bushing, case unit

TYPE: Shaft guidance systems, Linear bushing, case unit, Close type, Block type, Type SWA, inch size, Standart (NB)

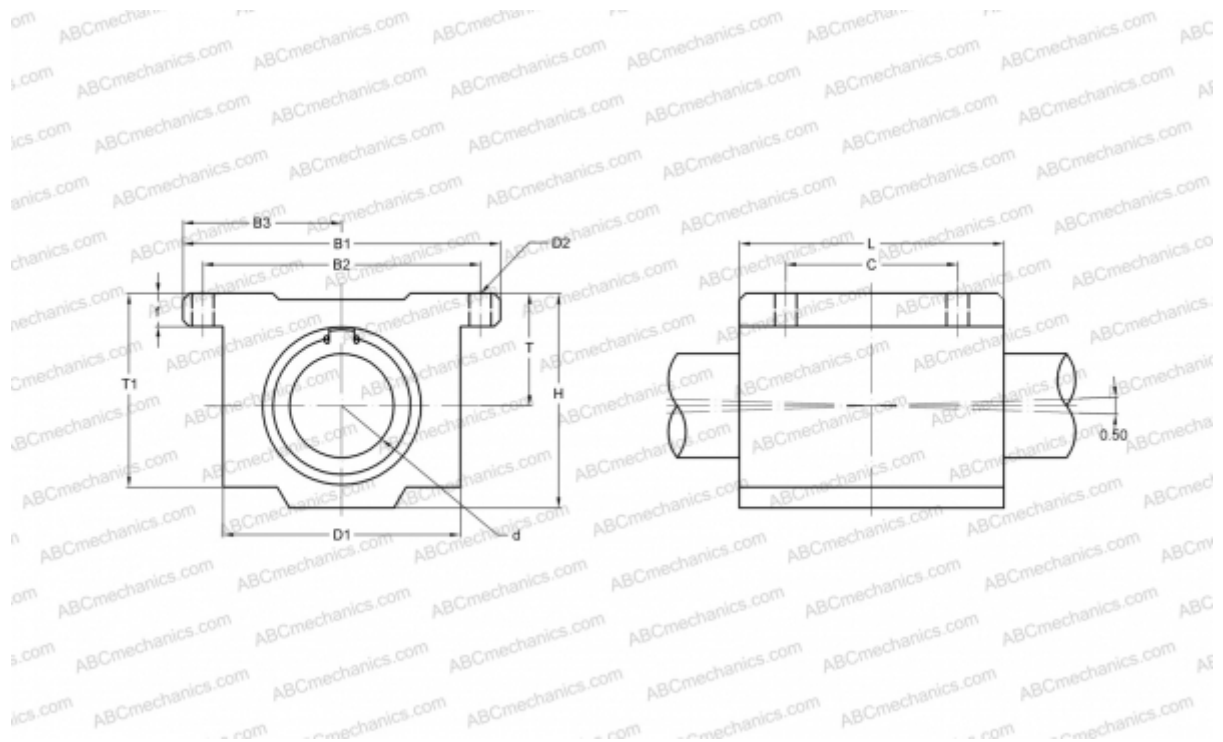

### Technical specification

#### DIMENSIONS, MM

B1	152,400
H	103,190
L	127,000
d	50,800
D1	114,300
D2	10,500
B2	133,350
B3	76,200
T	53,975
T1	92,080
f	15,880
C	82,550

**WEIGHT, KG** 3,600

**MANUFACTURER** [NB](#)