

SWSA 4GUU NB

Linear bushing, case unit

TYPE: Shaft guidance systems, Linear bushing, case unit, Close type, Block type, Type SWA, inch size, Corrosion resistance (NB)

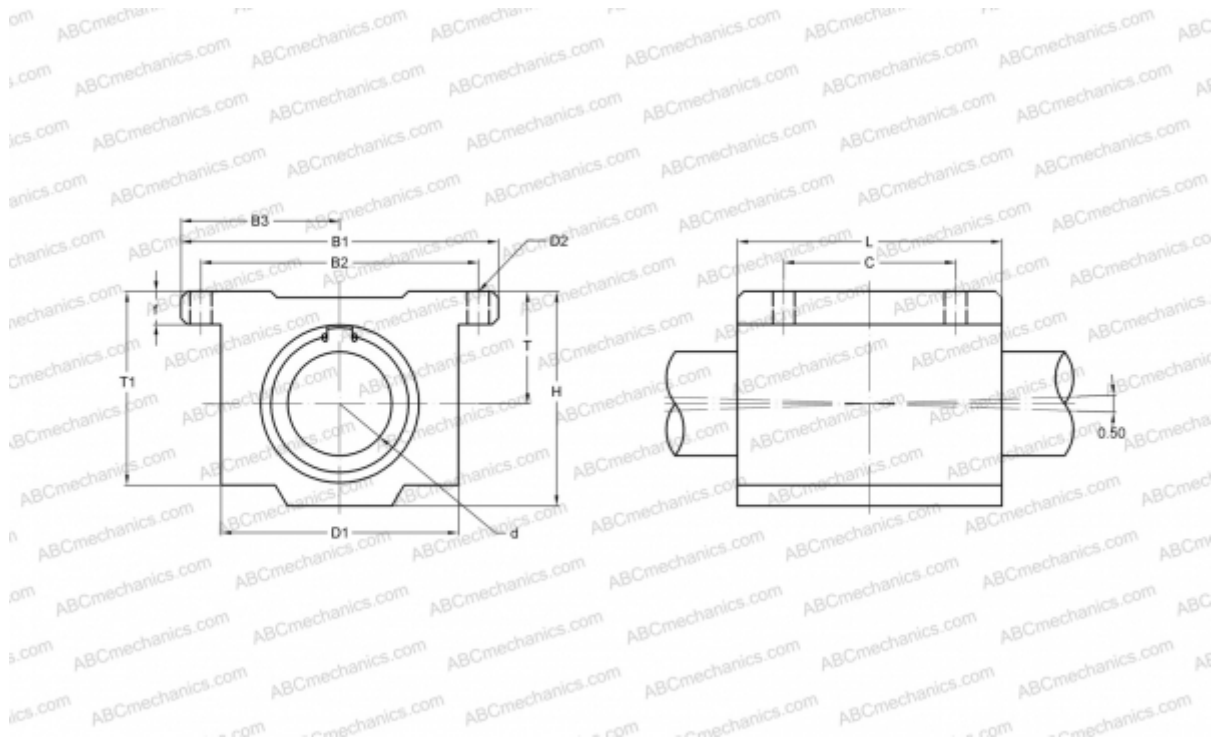

Technical specification

DIMENSIONS, MM

B1	41,280
H	20,640
L	30,160
d	6,350
D1	25,400
D2	3,960
B2	33,330
B3	20,638
T	11,100
T1	19,050
f	4,760
C	19,050

WEIGHT, KG 0,045

MANUFACTURER [NB](#)