

SWSA 6GUU NB

Linear bushing, case unit

TYPE: Shaft guidance systems, Linear bushing, case unit, Close type, Block type, Type SWA, inch size, Corrosion resistance (NB)

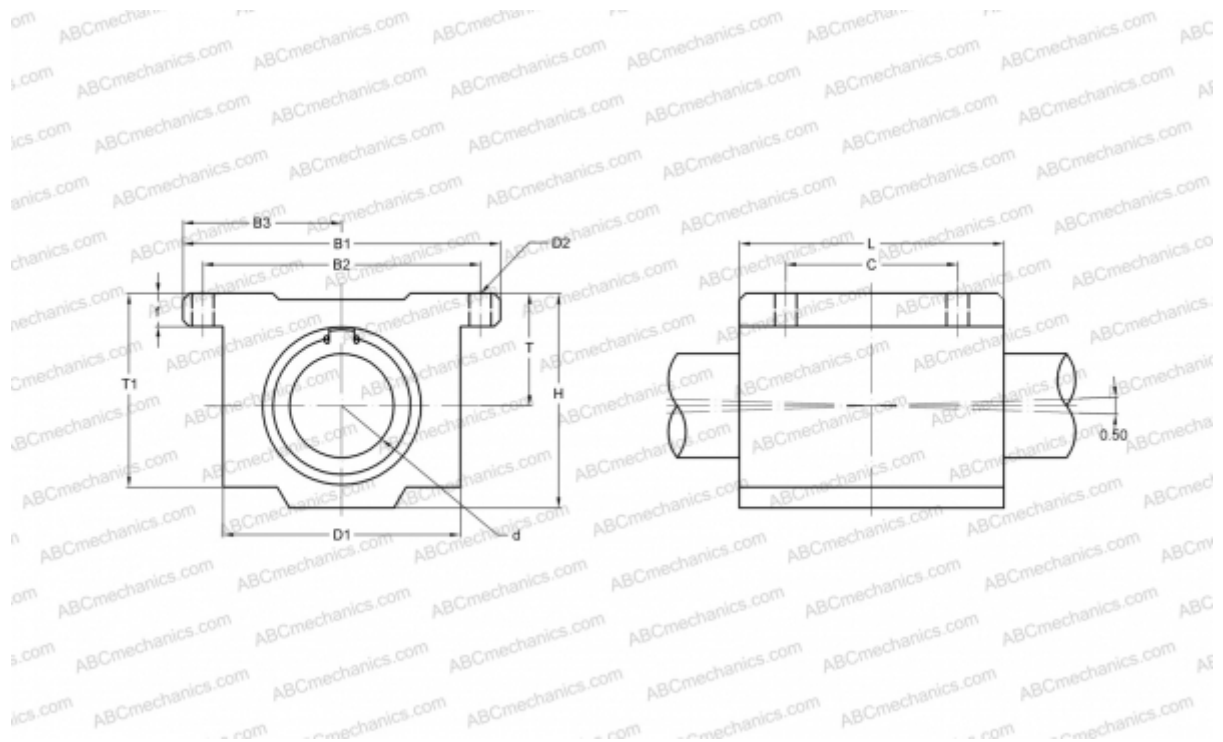

Technical specification

DIMENSIONS, MM

B1	44,450
H	23,820
L	33,340
d	9,525
D1	28,580
D2	3,960
B2	36,500
B3	22,225
T	12,700
T1	22,230
f	4,760
C	22,230

WEIGHT, KG 0,062

MANUFACTURER [NB](#)