

SWSA 10GUU NB

Linear bushing, case unit

TYPE: Shaft guidance systems, Linear bushing, case unit, Close type, Block type, Type SWA, inch size, Corrosion resistance (NB)

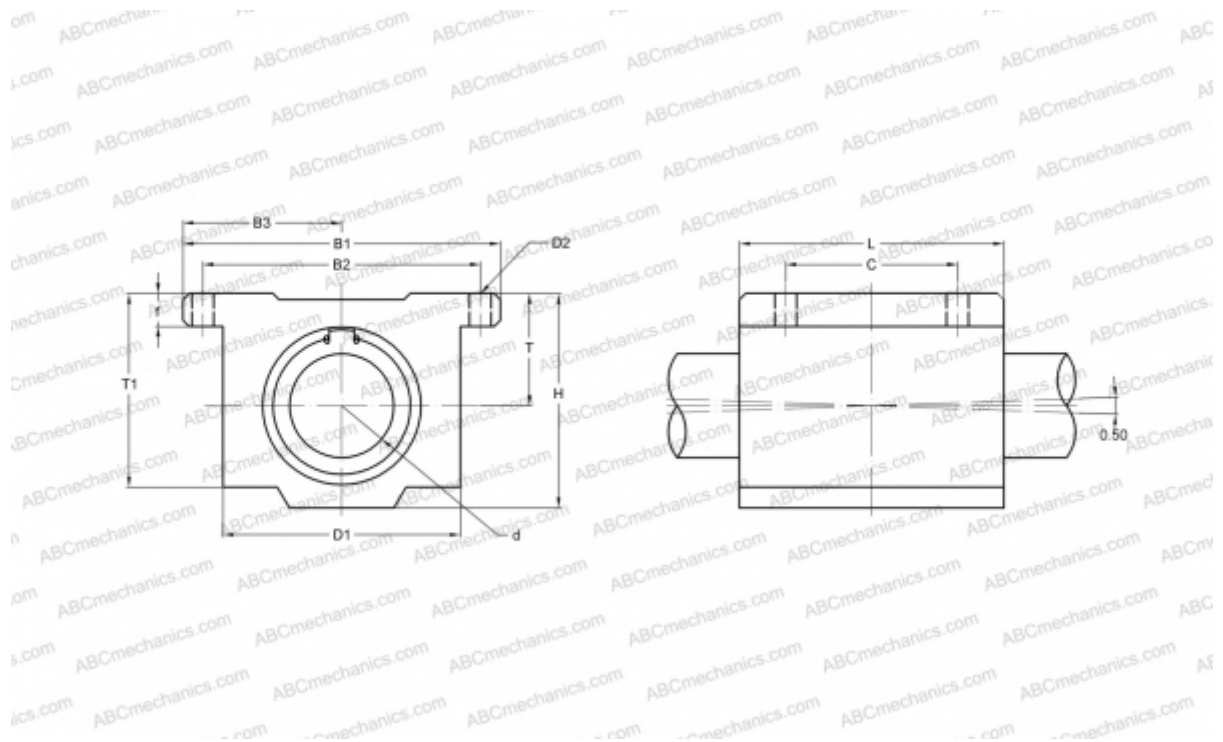

Technical specification

DIMENSIONS, MM

B1	63,500
H	41,280
L	49,210
d	15,875
D1	44,450
D2	4,760
B2	53,980
B3	31,750
T	22,225
T1	36,500
f	7,140
C	28,580

WEIGHT, KG 0,240

MANUFACTURER [NB](#)