

SWSA 12GUU NB

Linear bushing, case unit

TYPE: Shaft guidance systems, Linear bushing, case unit, Close type, Block type, Type SWA, inch size, Corrosion resistance (NB)

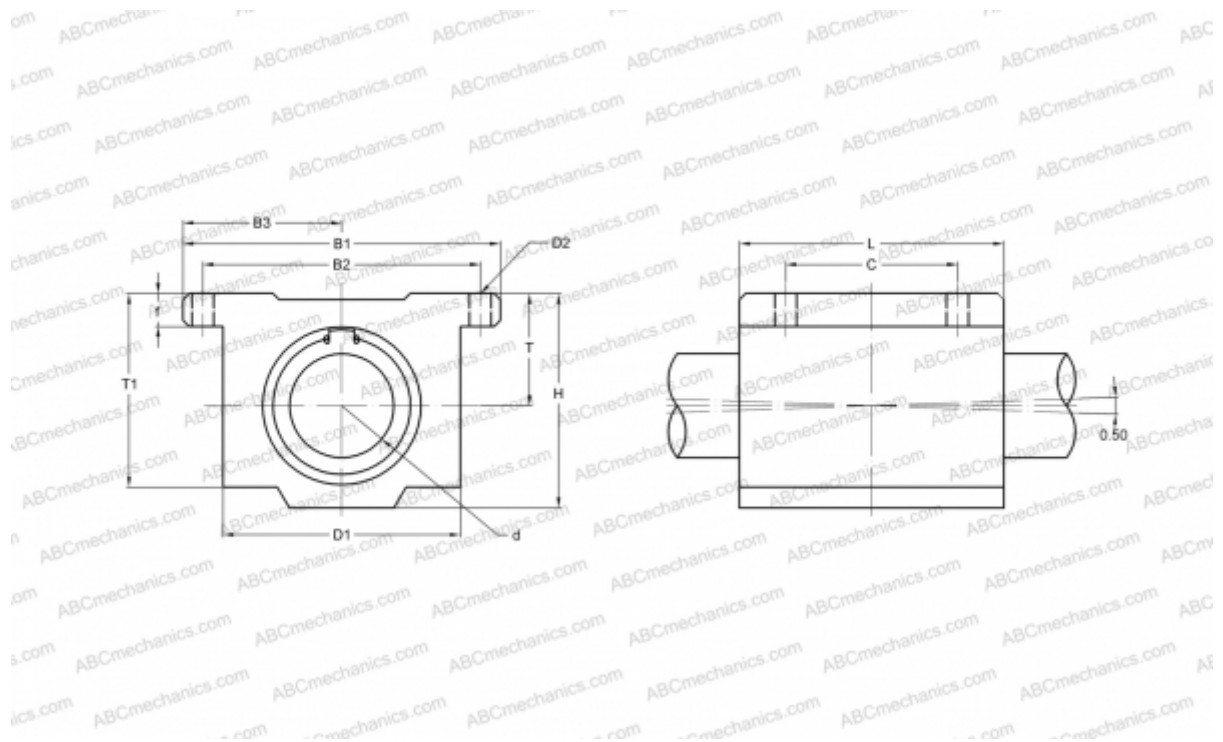

Technical specification

DIMENSIONS, MM

B1	69,850
H	44,450
L	52,390
d	19,050
D1	47,630
D2	4,760
B2	60,330
B3	34,925
T	23,800
T1	39,690
f	7,940
C	31,750

WEIGHT, KG 0,290

MANUFACTURER [NB](#)