

SMA 3GWUU NB

Linear bushing, case unit

TYPE: Shaft guidance systems, Linear bushing, case unit, Close type, Double-wide block type, Type SMA ..W, Standart (NB)

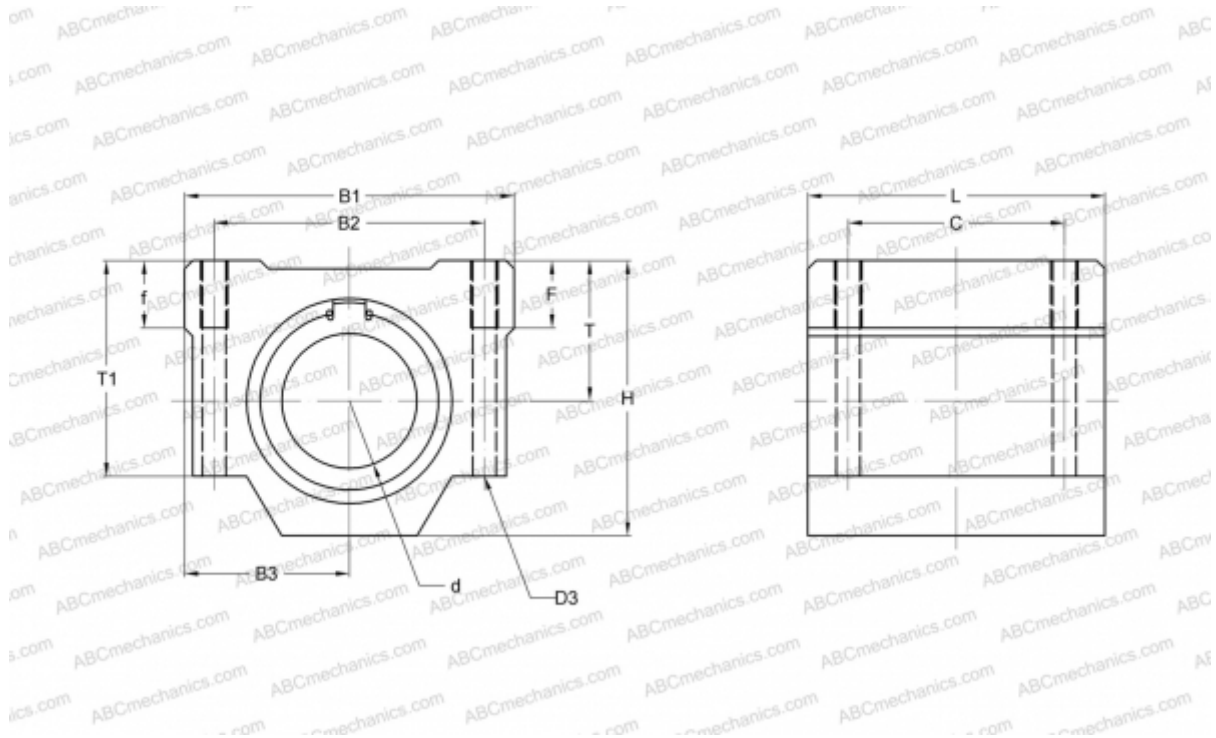

Technical specification

DIMENSIONS, MM

B1	16,000
H	10,000
L	23,000
d	3,000
B2	11,000
B3	8,000
T1	8,000
C	16,000

WEIGHT, KG 0,010

MANUFACTURER [NB](#)