

SMA13GWUU NB

Linear bushing, case unit

TYPE: Shaft guidance systems, Linear bushing, case unit, Close type, Double-wide block type, Type SMA ..W, Standart (NB)

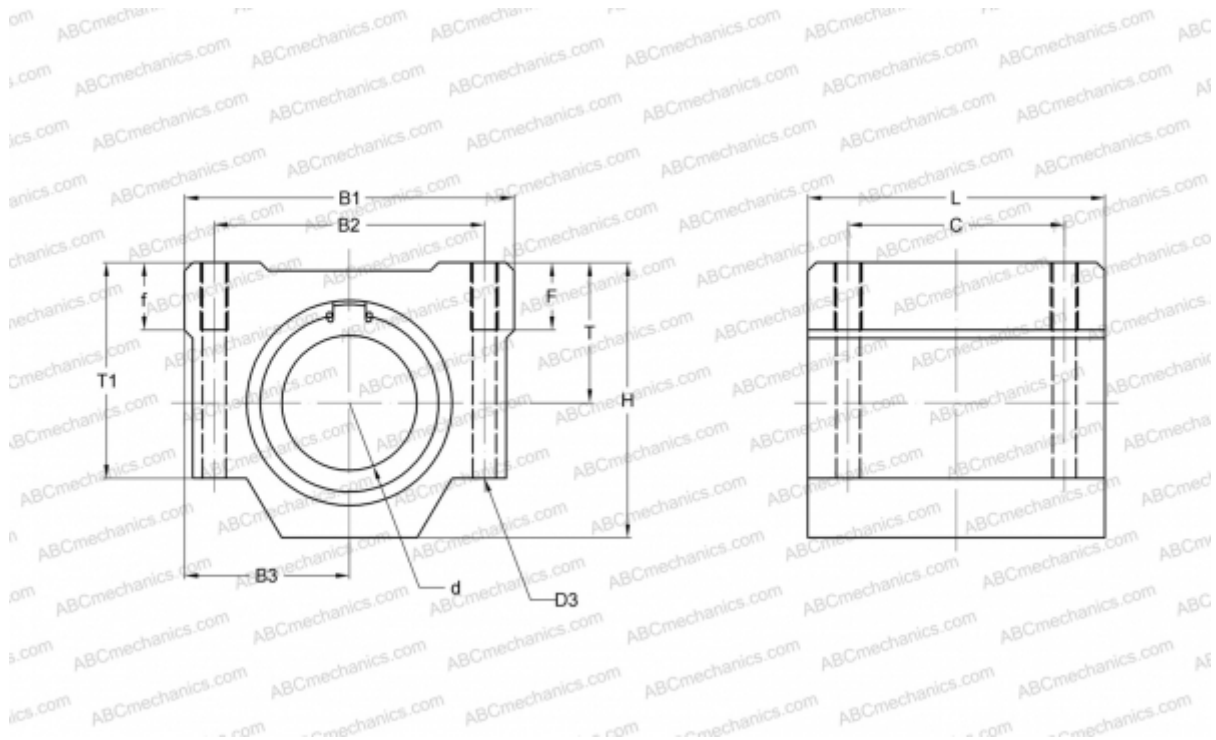

Technical specification

DIMENSIONS, MM

B1	44,000
H	30,000
L	75,000
d	13,000
D3	4,300
B2	33,000
B3	22,000
T1	24,500
f	8,000
C	50,000

WEIGHT, KG 0,240

MANUFACTURER [NB](#)