

## SMA20GWUU NB

Linear bushing, case unit

TYPE: Shaft guidance systems, Linear bushing, case unit, Close type, Double-wide block type, Type SMA ..W, Standart (NB)

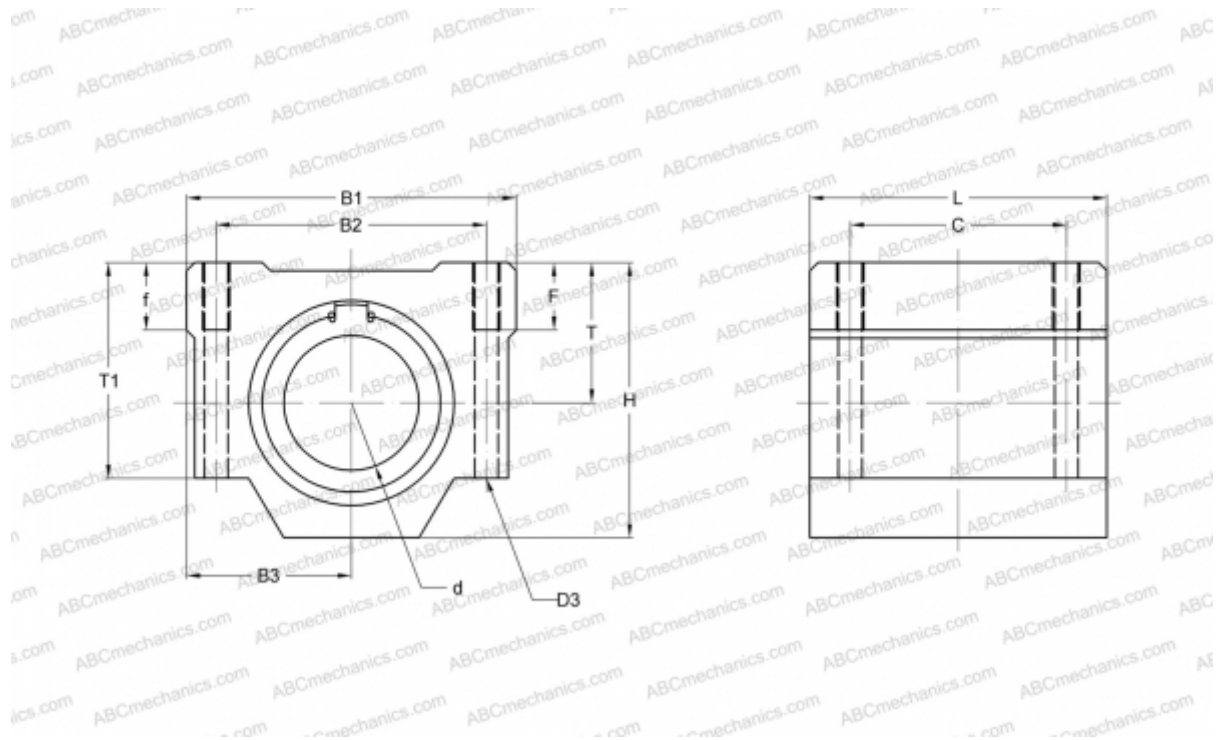

### Technical specification

#### DIMENSIONS, MM

B1	54,000
H	41,000
L	96,000
d	20,000
D3	5,200
B2	40,000
B3	27,000
T1	35,000
f	11,000
C	70,000

**WEIGHT, KG** 0,570

**MANUFACTURER** [NB](#)