

## SMA30GWUU NB

Linear bushing, case unit

TYPE: Shaft guidance systems, Linear bushing, case unit, Close type, Double-wide block type, Type SMA ..W, Standart (NB)

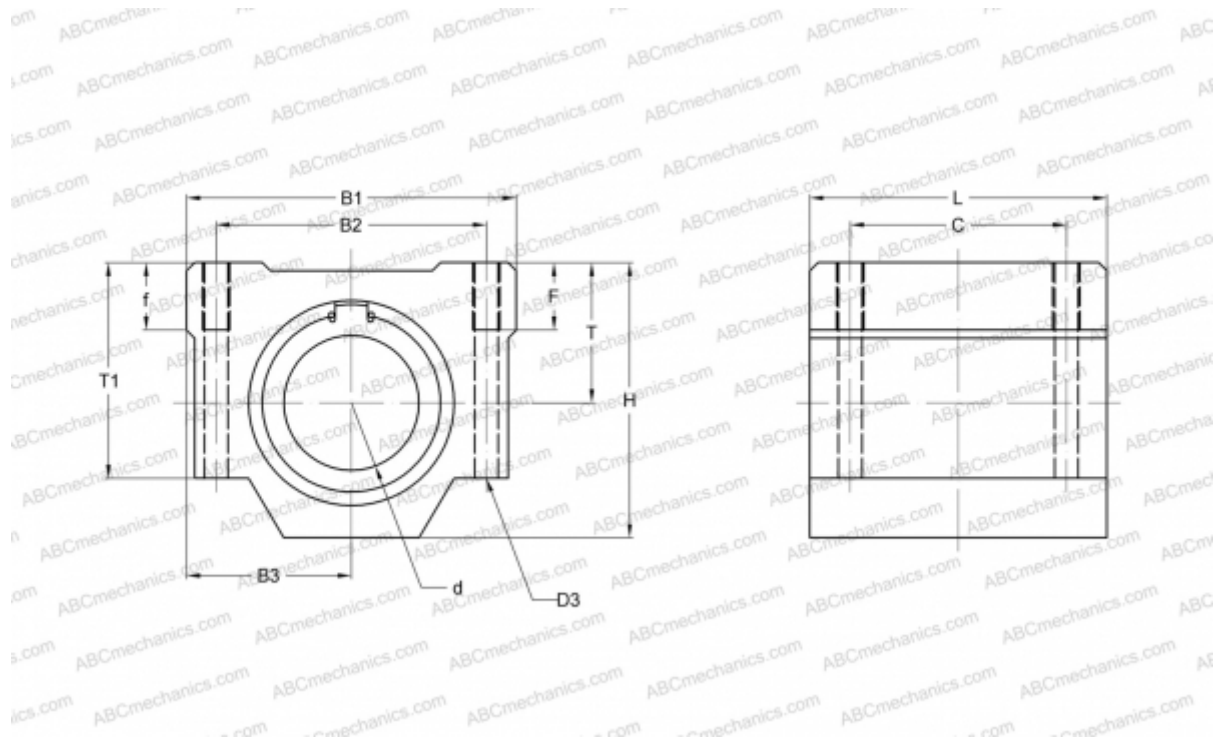

### Technical specification

#### DIMENSIONS, MM

B1	78,000
H	59,500
L	140,000
d	30,000
D3	7,000
B2	58,000
B3	39,000
T1	49,000
f	15,000
C	110,000

**WEIGHT, KG** 1,480

**MANUFACTURER** [NB](#)