

SMA35GWUU NB

Linear bushing, case unit

TYPE: Shaft guidance systems, Linear bushing, case unit, Close type, Double-wide block type, Type SMA ..W, Standart (NB)

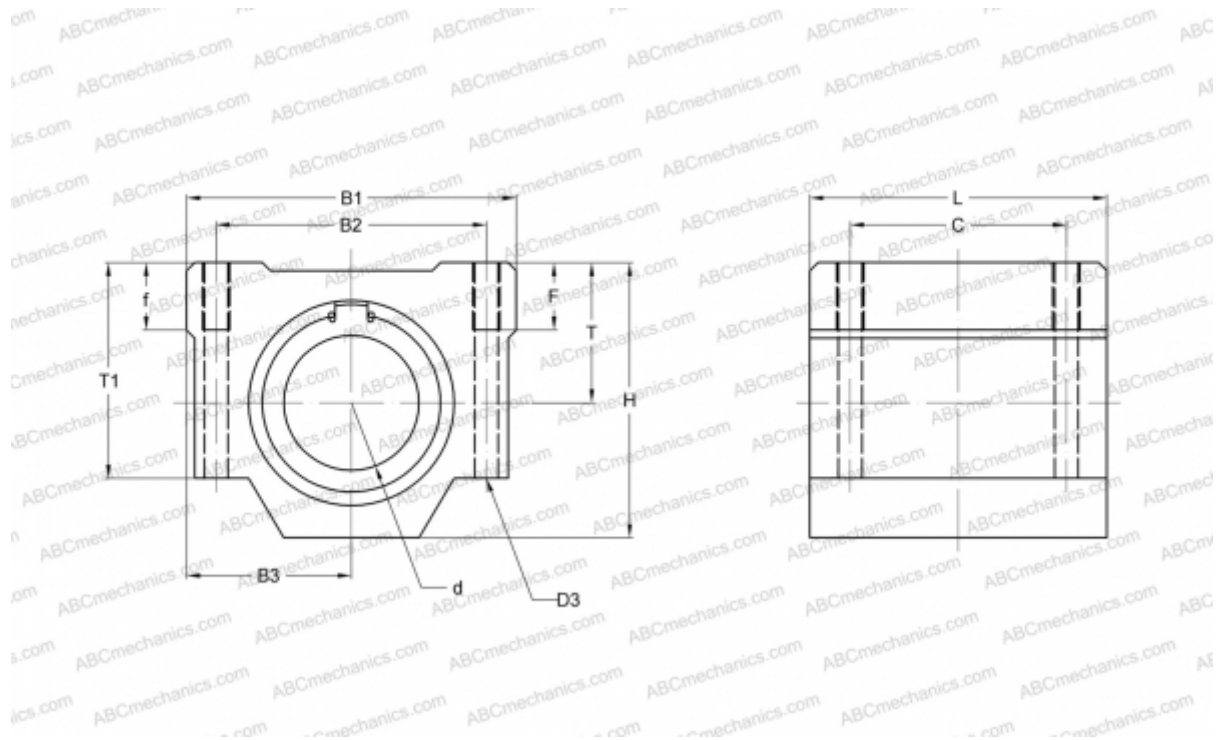

Technical specification

DIMENSIONS, MM

B1	90,000
H	68,000
L	155,000
d	35,000
D3	7,000
B2	70,000
B3	45,000
T1	54,000
f	18,000
C	120,000

WEIGHT, KG 2,200

MANUFACTURER [NB](#)