

SMA40GWUU NB

Linear bushing, case unit

TYPE: Shaft guidance systems, Linear bushing, case unit, Close type, Double-wide block type, Type SMA ..W, Standart (NB)

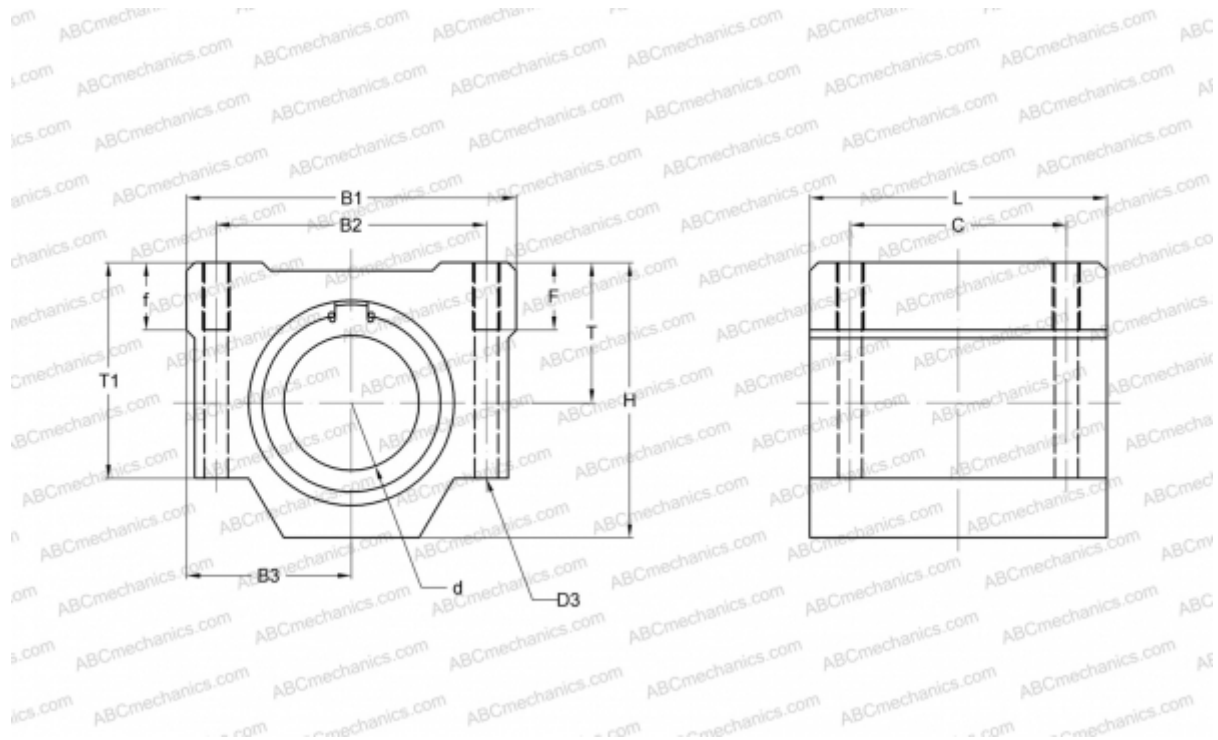

Technical specification

DIMENSIONS, MM

B1	102,000
H	78,000
L	175,000
d	40,000
D3	8,700
B2	80,000
B3	51,000
T1	62,000
f	20,000
C	140,000

WEIGHT, KG 3,200

MANUFACTURER [NB](#)