

SMSA 6GWUU NB

Linear bushing, case unit

TYPE: Shaft guidance systems, Linear bushing, case unit, Close type, Double-wide block type, Type SMA ..W, Corrosion resistance (NB)

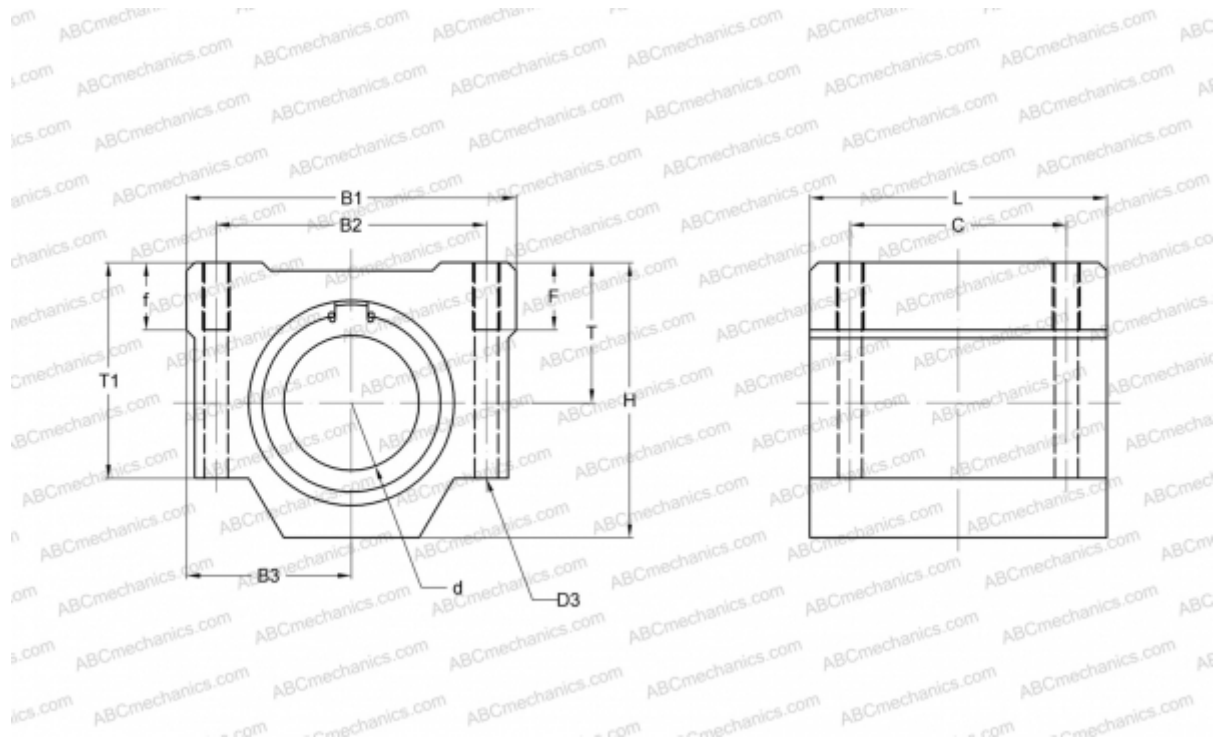

Technical specification

DIMENSIONS, MM

B1	30,000
H	18,000
L	48,000
d	6,000
D3	3,400
B2	20,000
B3	15,000
T1	15,000
f	6,000
C	36,000

WEIGHT, KG 0,063

MANUFACTURER [NB](#)