

SMSA12GWUU NB

Linear bushing, case unit

TYPE: Shaft guidance systems, Linear bushing, case unit, Close type, Double-wide block type, Type SMA ..W, Corrosion resistance (NB)

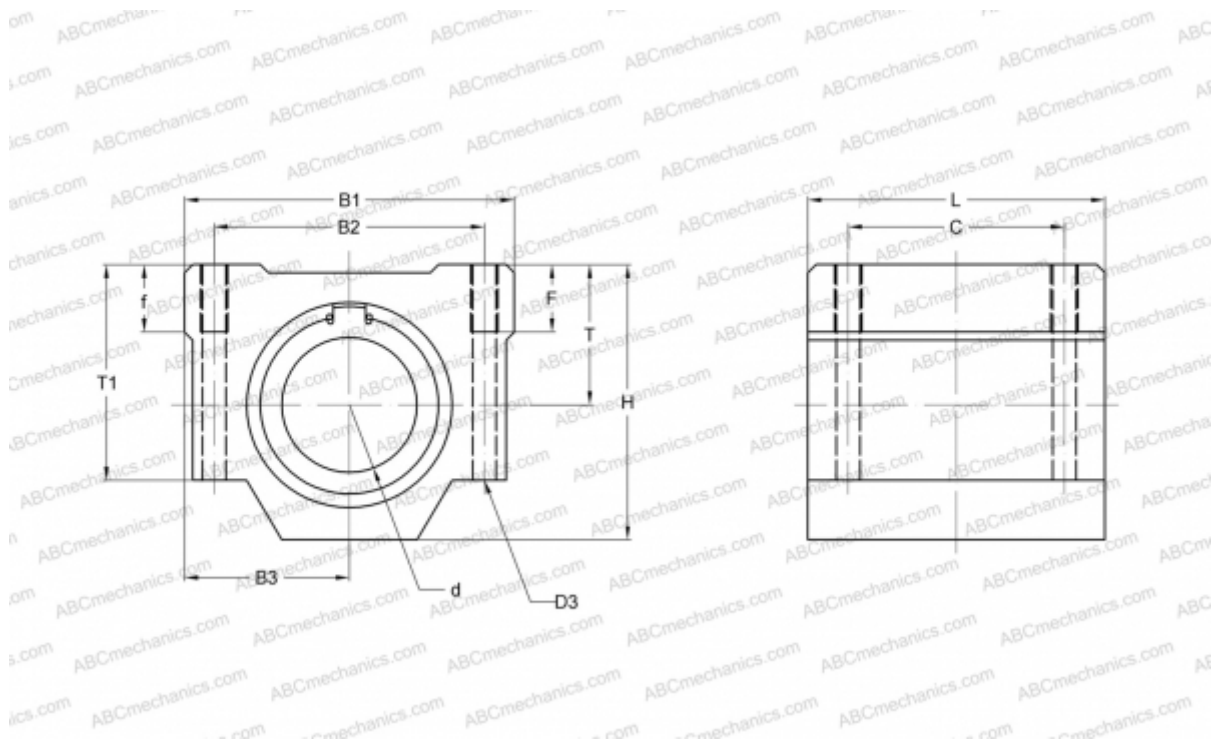

Technical specification

DIMENSIONS, MM

B1	42,000
H	28,000
L	70,000
d	12,000
D3	4,300
B2	30,500
B3	21,000
T1	24,000
f	8,000
C	50,000

WEIGHT, KG 0,205

MANUFACTURER [NB](#)