

## SMSA16GWUU NB

Linear bushing, case unit

TYPE: Shaft guidance systems, Linear bushing, case unit, Close type, Double-wide block type, Type SMA ..W, Corrosion resistance (NB)

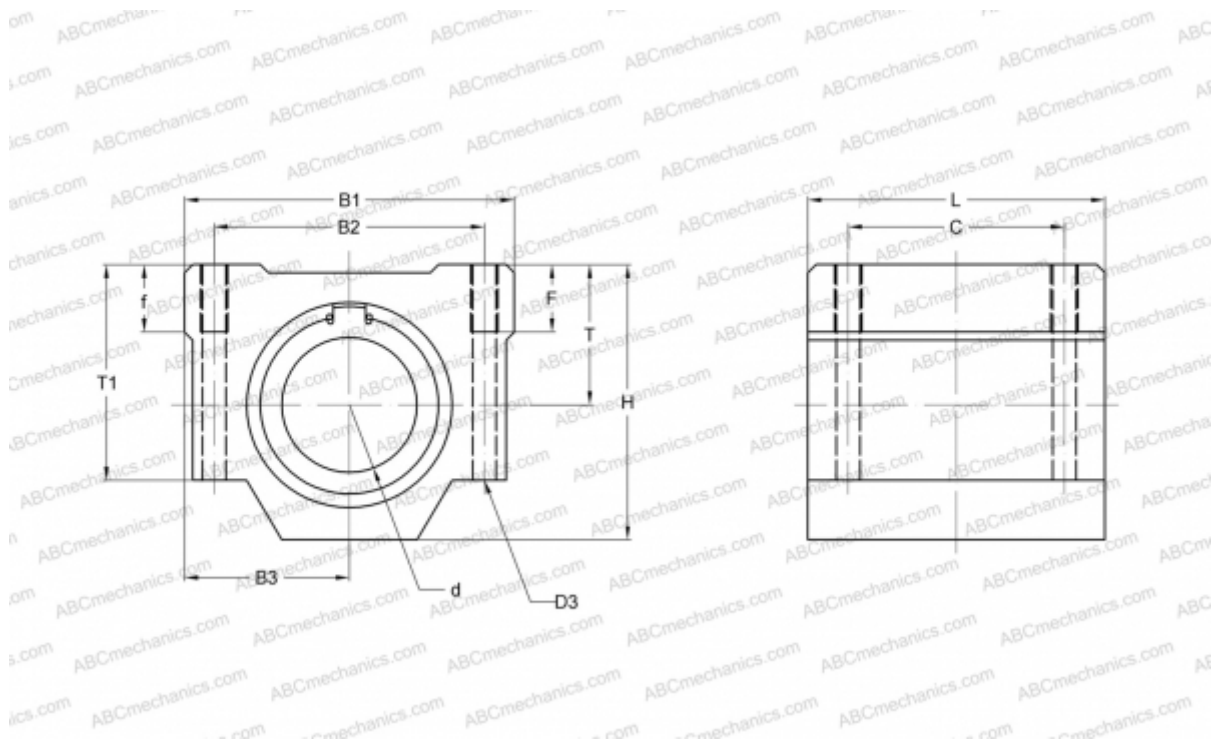

### Technical specification

#### DIMENSIONS, MM

B1	50,000
H	38,500
L	85,000
d	16,000
D3	4,300
B2	36,000
B3	25,000
T1	32,500
f	9,000
C	60,000

**WEIGHT, KG** 0,400

**MANUFACTURER** [NB](#)