

SMJ35GUU NB

Linear bushing, case unit

TYPE: Shaft guidance systems, Linear bushing, case unit, Close type, Clearance adjustable type, Type SMJ, Standart (NB)

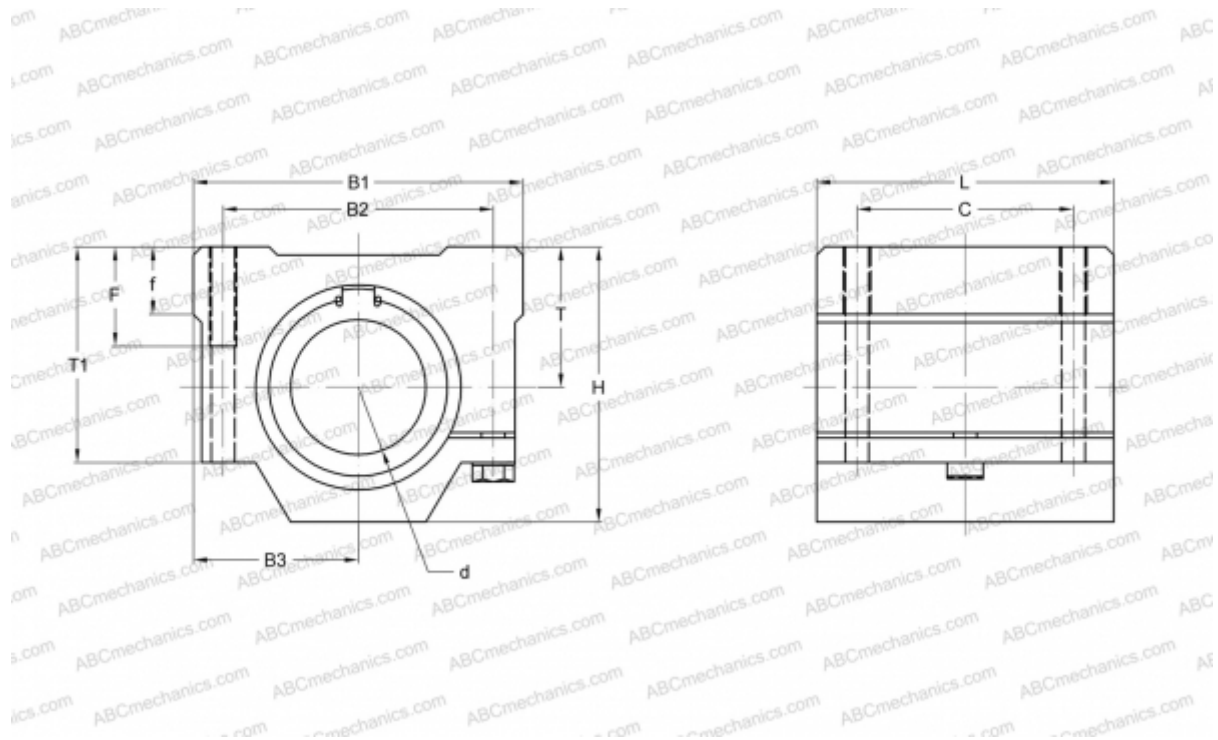

Technical specification

DIMENSIONS, MM

B1	90,000
H	68,000
L	80,000
d	35,000
B2	70,000
B3	45,000
T	34,000
T1	54,000
f	18,000
C	60,000
F	18

WEIGHT, KG 1,100

MANUFACTURER [NB](#)