

SMSJ10GUU NB

Linear bushing, case unit

TYPE: Shaft guidance systems, Linear bushing, case unit, Close type, Clearance adjustable type, Type SMJ, Corrosion resistance (NB)

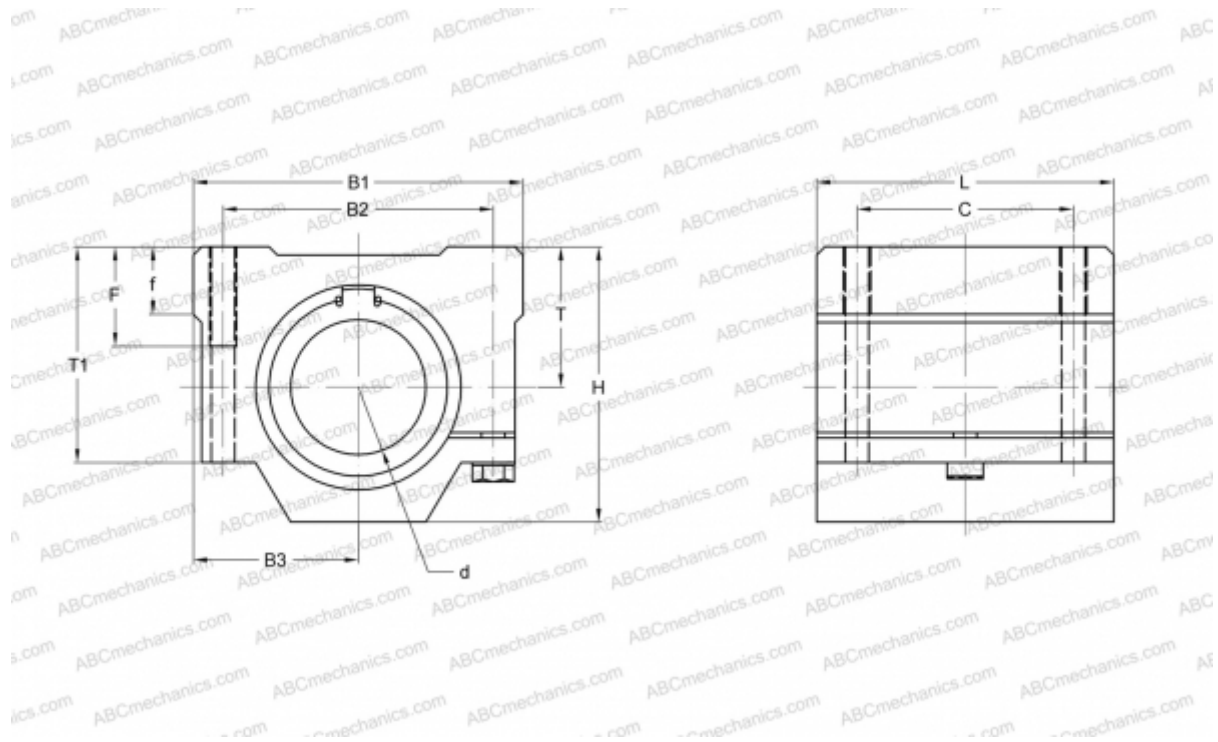

Technical specification

DIMENSIONS, MM

B1	40,000
H	26,000
L	35,000
d	10,000
B2	28,000
B3	20,000
T	13,000
T1	21,000
f	8,000
C	21,000
F	12

WEIGHT, KG 0,092

MANUFACTURER [NB](#)