

SMSJ30GUU NB

Linear bushing, case unit

TYPE: Shaft guidance systems, Linear bushing, case unit, Close type, Clearance adjustable type, Type SMJ, Corrosion resistance (NB)

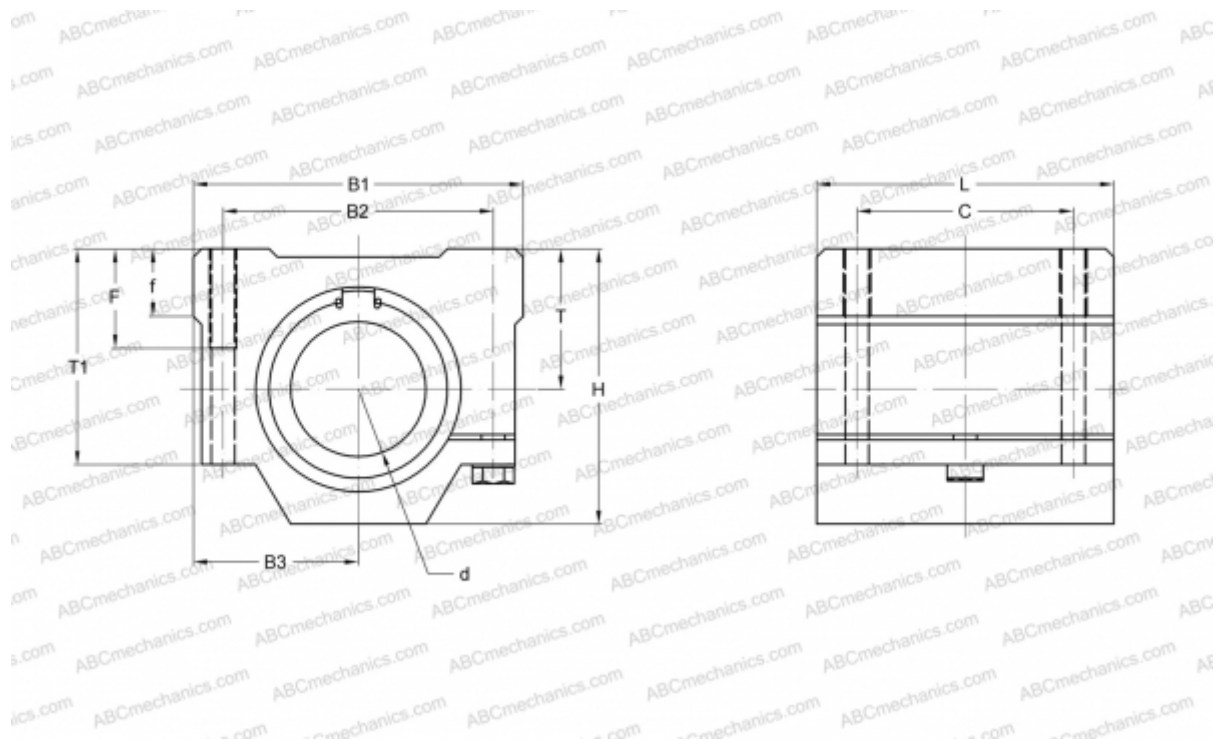

Technical specification

DIMENSIONS, MM

B1	78,000
H	59,500
L	72,000
d	30,000
B2	58,000
B3	39,000
T	30,000
T1	49,000
f	15,000
C	58,000
F	18

WEIGHT, KG 0,735

MANUFACTURER [NB](#)