

SMSJ40GUU NB

Linear bushing, case unit

TYPE: Shaft guidance systems, Linear bushing, case unit, Close type, Clearance adjustable type, Type SMJ, Corrosion resistance (NB)

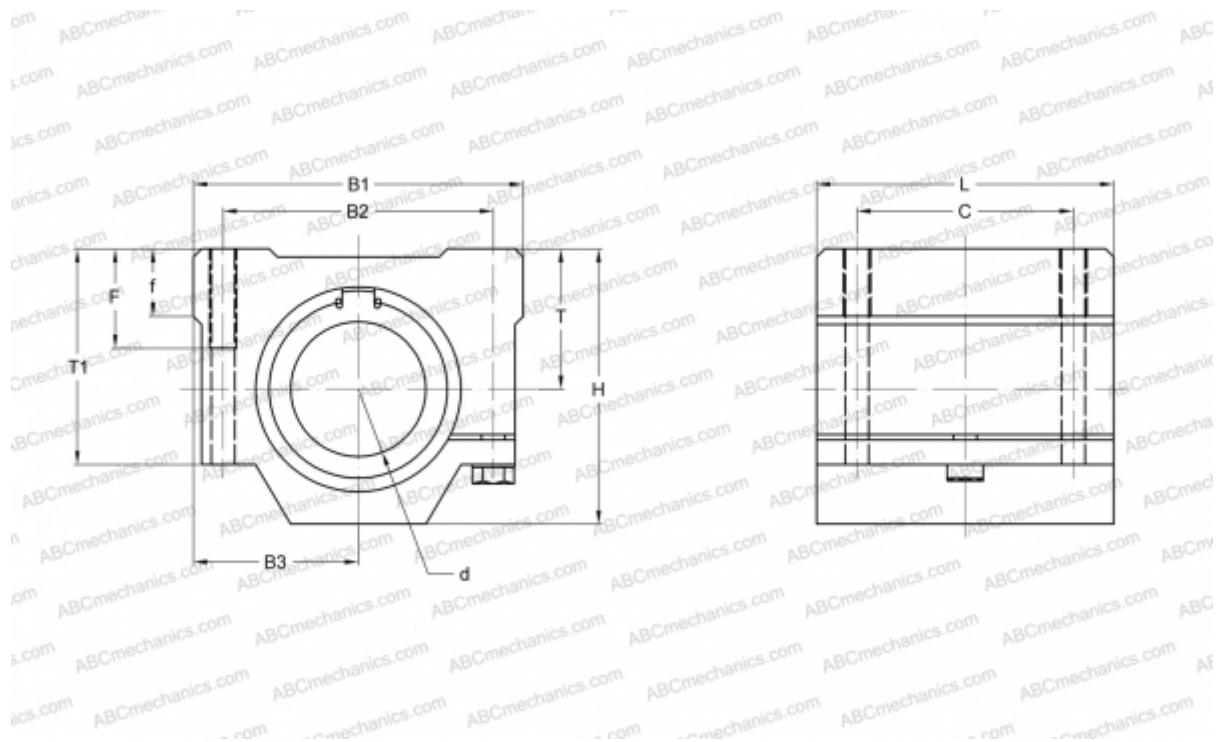

Technical specification

DIMENSIONS, MM

B1	102,000
H	78,000
L	90,000
d	40,000
B2	80,000
B3	51,000
T	40,000
T1	62,000
f	20,000
C	60,000
F	25

WEIGHT, KG 1,590

MANUFACTURER [NB](#)