

SMSJ60GUU NB

Linear bushing, case unit

TYPE: Shaft guidance systems, Linear bushing, case unit, Close type, Clearance adjustable type, Type SMJ, Corrosion resistance (NB)

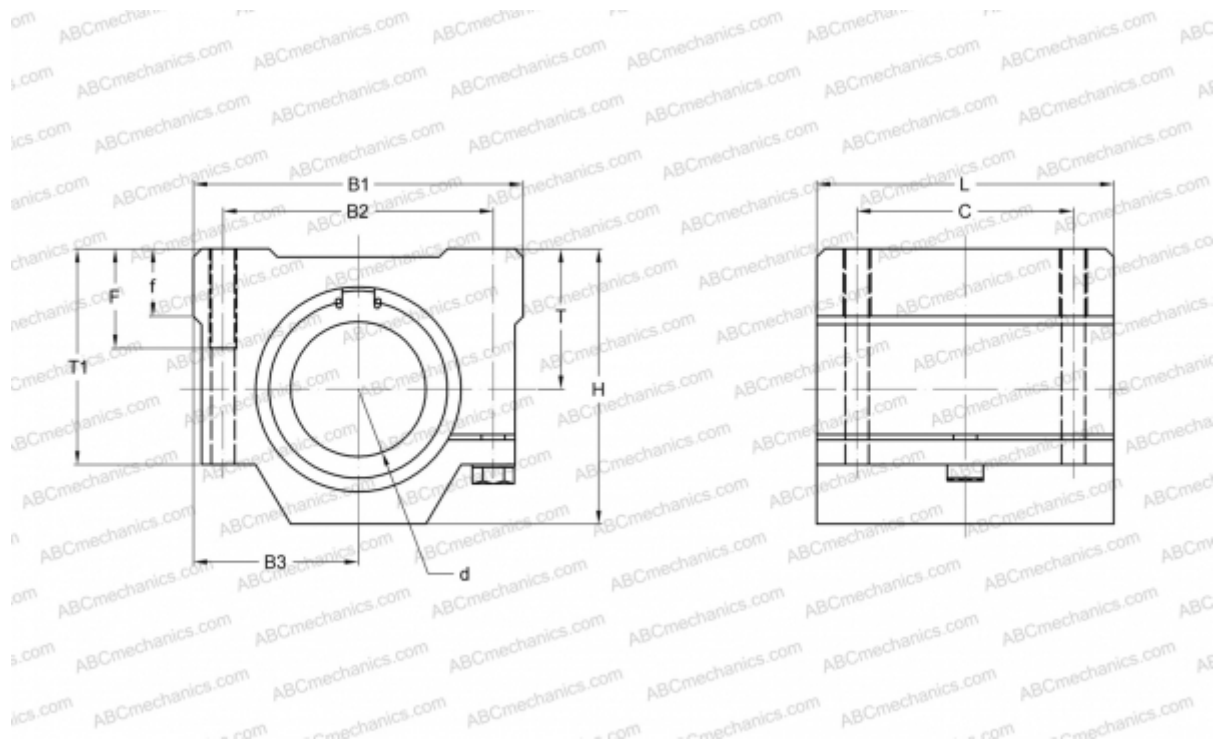

Technical specification

DIMENSIONS, MM

B1	132,000
H	114,000
L	122,000
d	60,000
B2	108,000
B3	66,000
T	58,000
T1	94,000
f	30,000
C	90,000
F	25

WEIGHT, KG 4,270

MANUFACTURER [NB](#)