

## SWSJ 8GUU NB

Linear bushing, case unit

TYPE: Shaft guidance systems, Linear bushing, case unit, Close type, Clearance adjustable type, Type SWJ, inch size, Corrosion resistance (NB)

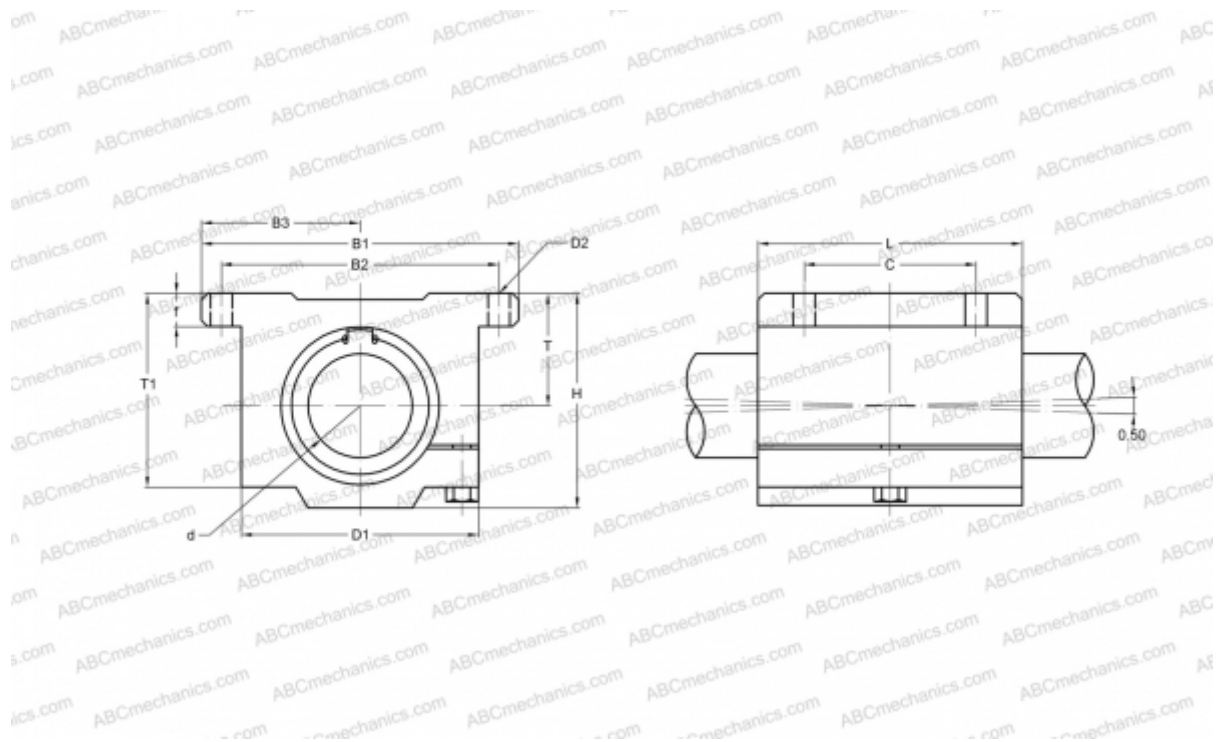

### Technical specification

#### DIMENSIONS, MM

B1	50,800
H	31,750
L	42,860
d	12,700
D1	34,930
D2	3,960
B2	42,880
B3	25,400
T	17,450
T1	28,580
f	6,350
C	25,400

**WEIGHT, KG** 0,130

**MANUFACTURER** [NB](#)