

## SWSJ 10GUU NB

Linear bushing, case unit

TYPE: Shaft guidance systems, Linear bushing, case unit, Close type, Clearance adjustable type, Type SWJ, inch size, Corrosion resistance (NB)

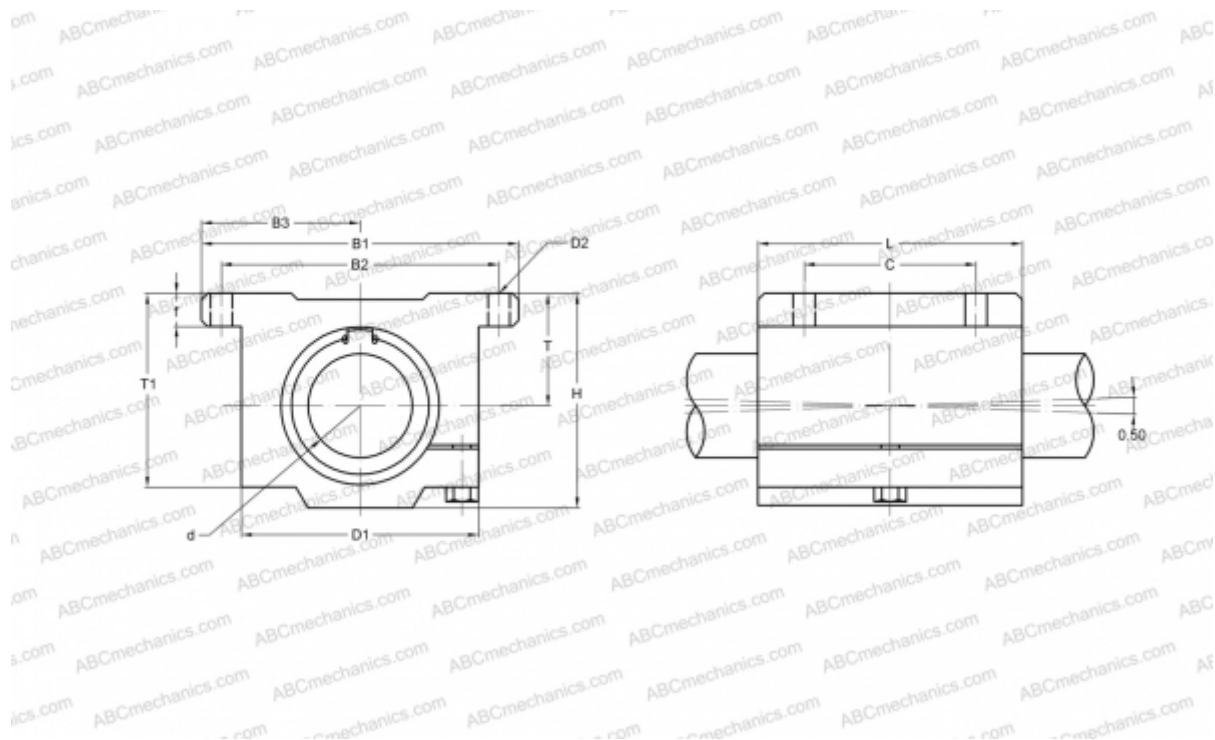

### Technical specification

#### DIMENSIONS, MM

B1	63,500
H	41,280
L	49,210
d	15,875
D1	44,450
D2	4,760
B2	53,980
B3	31,750
T	22,225
T1	36,500
f	7,140
C	28,580

**WEIGHT, KG** 0,240

**MANUFACTURER** [NB](#)