

SWSJ 16GUU NB

Linear bushing, case unit

TYPE: Shaft guidance systems, Linear bushing, case unit, Close type, Clearance adjustable type, Type SWJ, inch size, Corrosion resistance (NB)

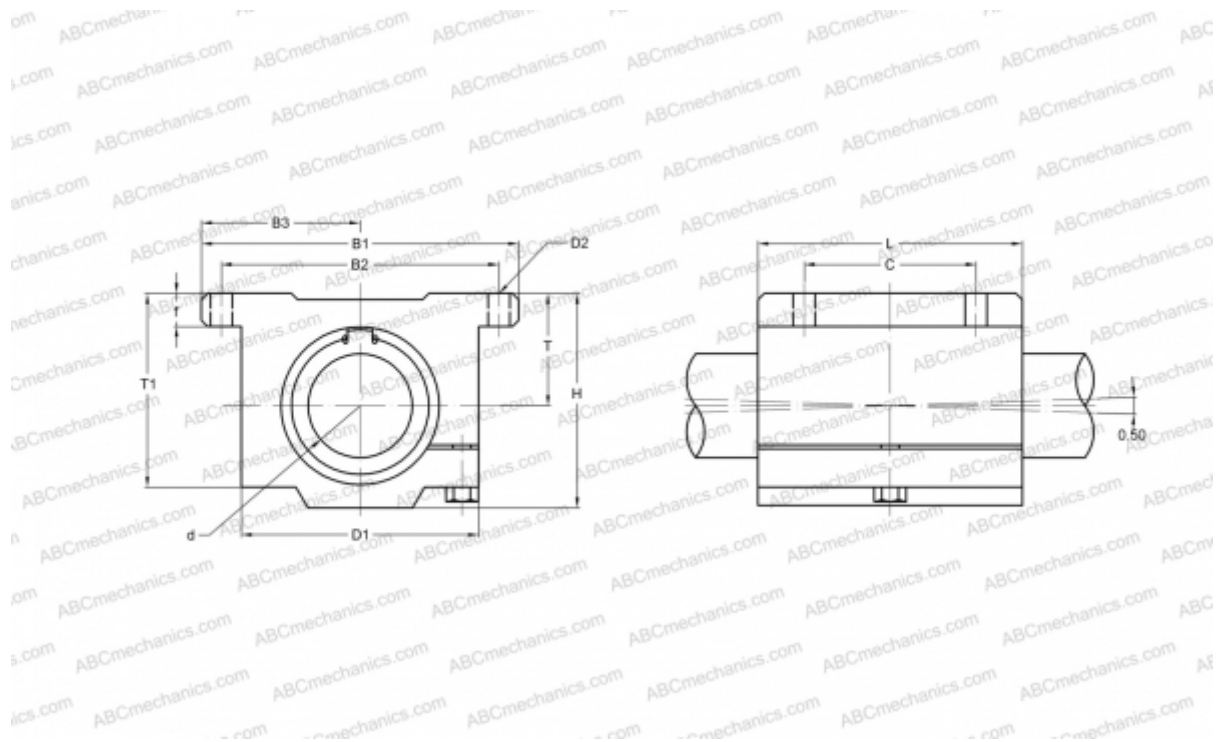

Technical specification

DIMENSIONS, MM

B1	82,550
H	55,560
L	71,440
d	25,400
D1	60,330
D2	5,560
B2	73,030
B3	41,275
T	30,150
T1	49,210
f	9,530
C	44,450

WEIGHT, KG 0,615

MANUFACTURER [NB](#)