

SME10GUU NB

Linear bushing, case unit

TYPE: Shaft guidance systems, Linear bushing, case unit, Open type, Block type, Type SME, Standart (NB)

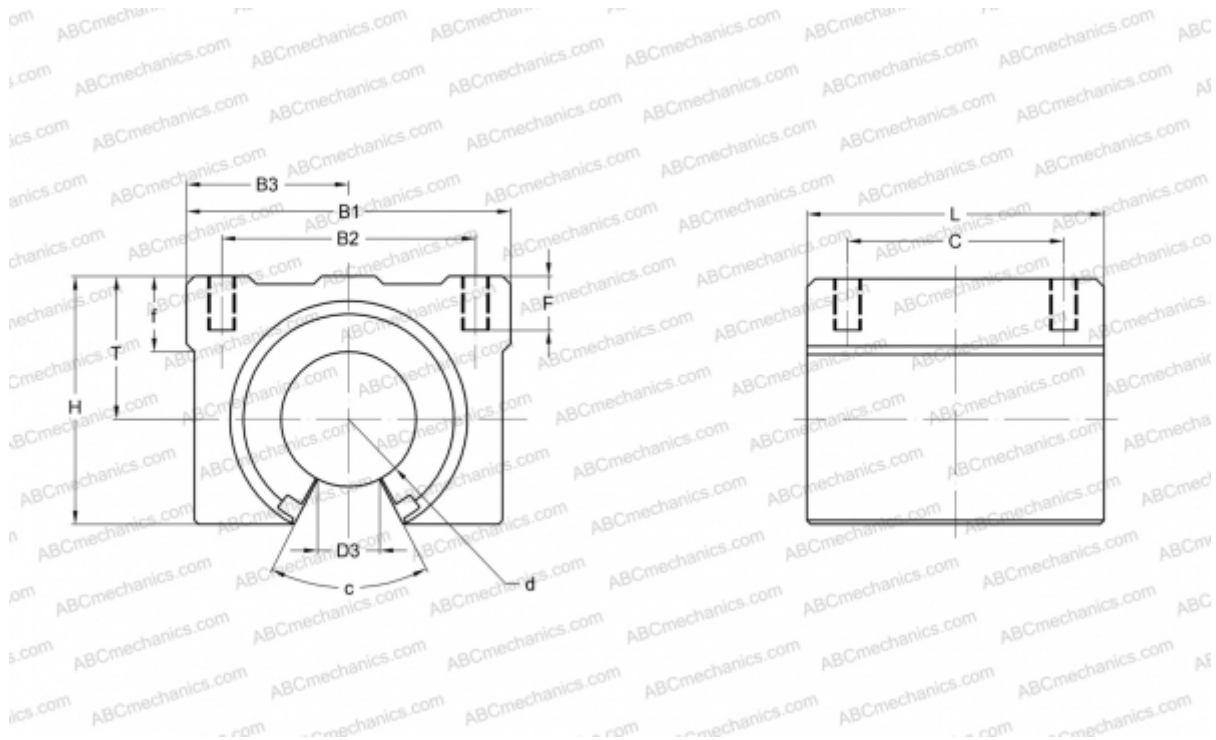

Technical specification

DIMENSIONS, MM

B1	36,000
H	24,000
L	32,000
d	10,000
D3	6,000
B2	25,000
B3	18,000
T	15,000
f	7,000
C	20,000
c	80
F	10

WEIGHT, KG 0,065

MANUFACTURER [NB](#)