

SME13GUU NB

Linear bushing, case unit

TYPE: Shaft guidance systems, Linear bushing, case unit, Open type, Block type, Type SME, Standart (NB)

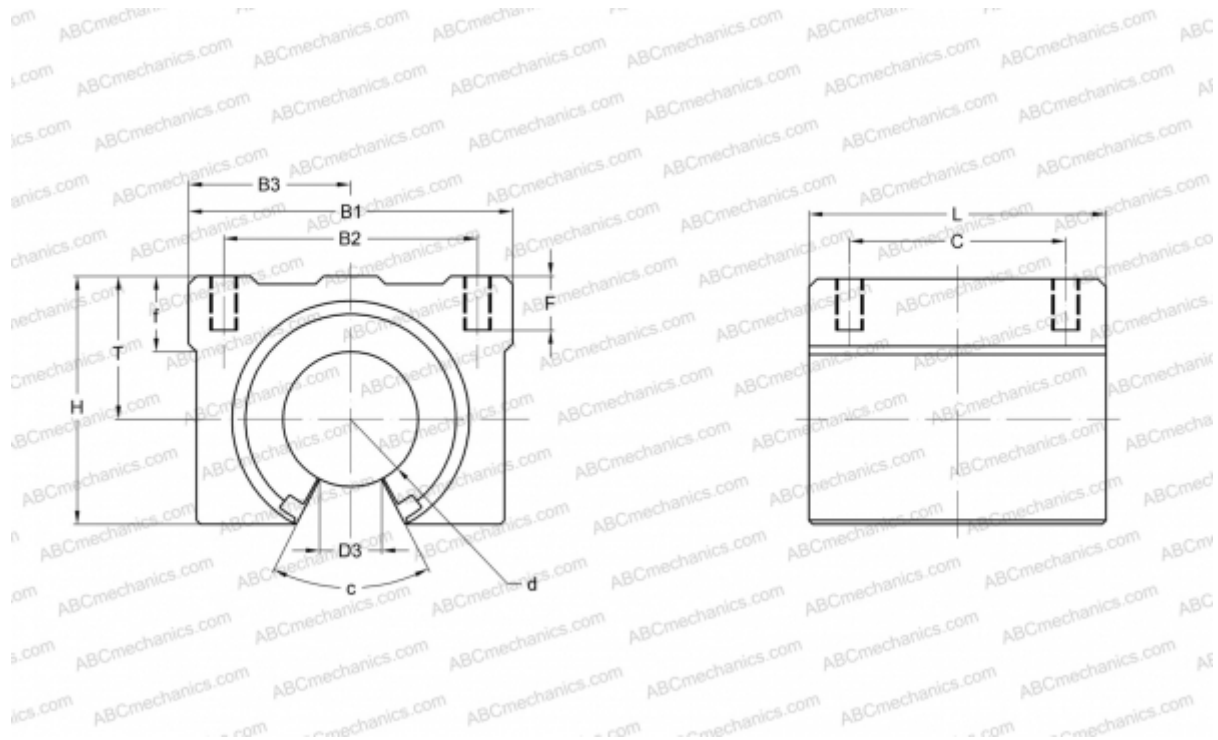

Technical specification

DIMENSIONS, MM

B1	40,000
H	28,000
L	39,000
d	13,000
D3	8,500
B2	28,000
B3	20,000
T	17,000
f	8,000
C	26,000
c	80
F	10

WEIGHT, KG 0,100

MANUFACTURER [NB](#)