

SME16GUU NB

Linear bushing, case unit

TYPE: Shaft guidance systems, Linear bushing, case unit, Open type, Block type, Type SME, Standart (NB)

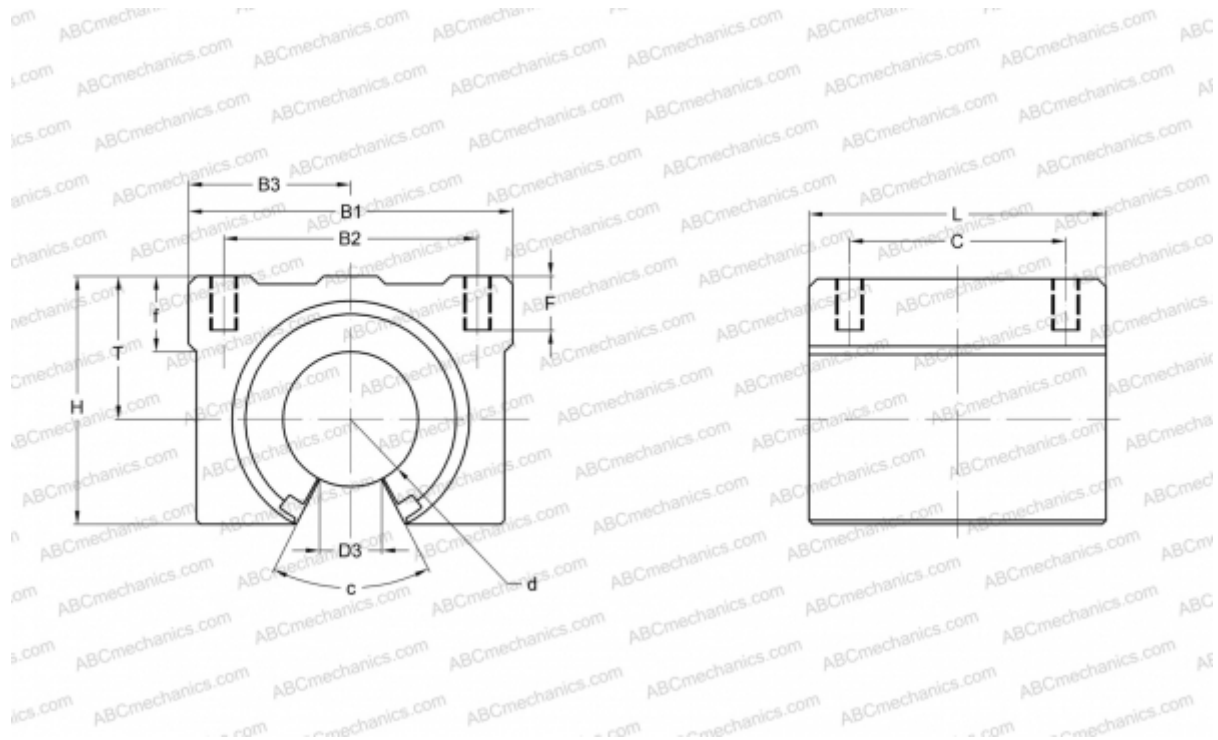

Technical specification

DIMENSIONS, MM

B1	45,000
H	33,000
L	45,000
d	16,000
D3	10,000
B2	32,000
B3	22,500
T	20,000
f	9,000
C	30,000
c	80
F	12

WEIGHT, KG 0,150

MANUFACTURER [NB](#)