

SME20GUU NB

Linear bushing, case unit

TYPE: Shaft guidance systems, Linear bushing, case unit, Open type, Block type, Type SME, Standart (NB)

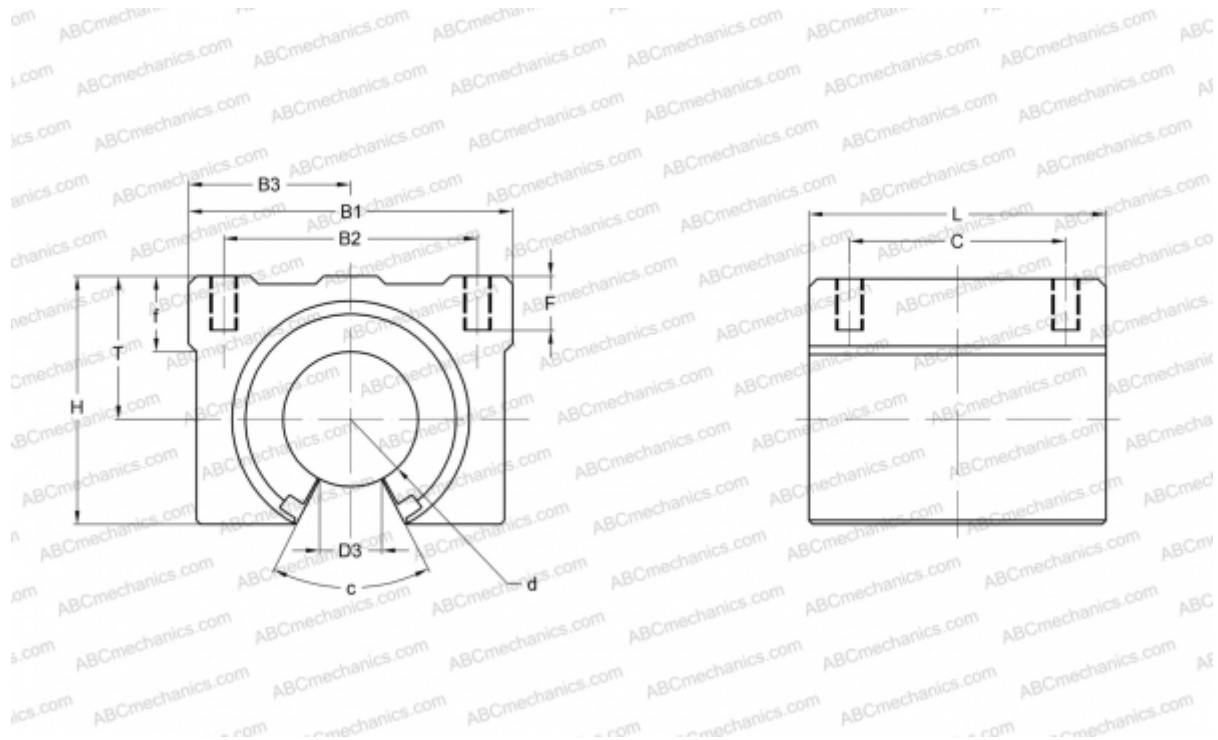

Technical specification

DIMENSIONS, MM

B1	48,000
H	39,000
L	50,000
d	20,000
D3	10,000
B2	35,000
B3	24,000
T	23,000
f	11,000
C	35,000
c	60
F	12

WEIGHT, KG 0,200

MANUFACTURER [NB](#)