

## SME30GUU NB

Linear bushing, case unit

TYPE: Shaft guidance systems, Linear bushing, case unit, Open type, Block type, Type SME, Standart (NB)

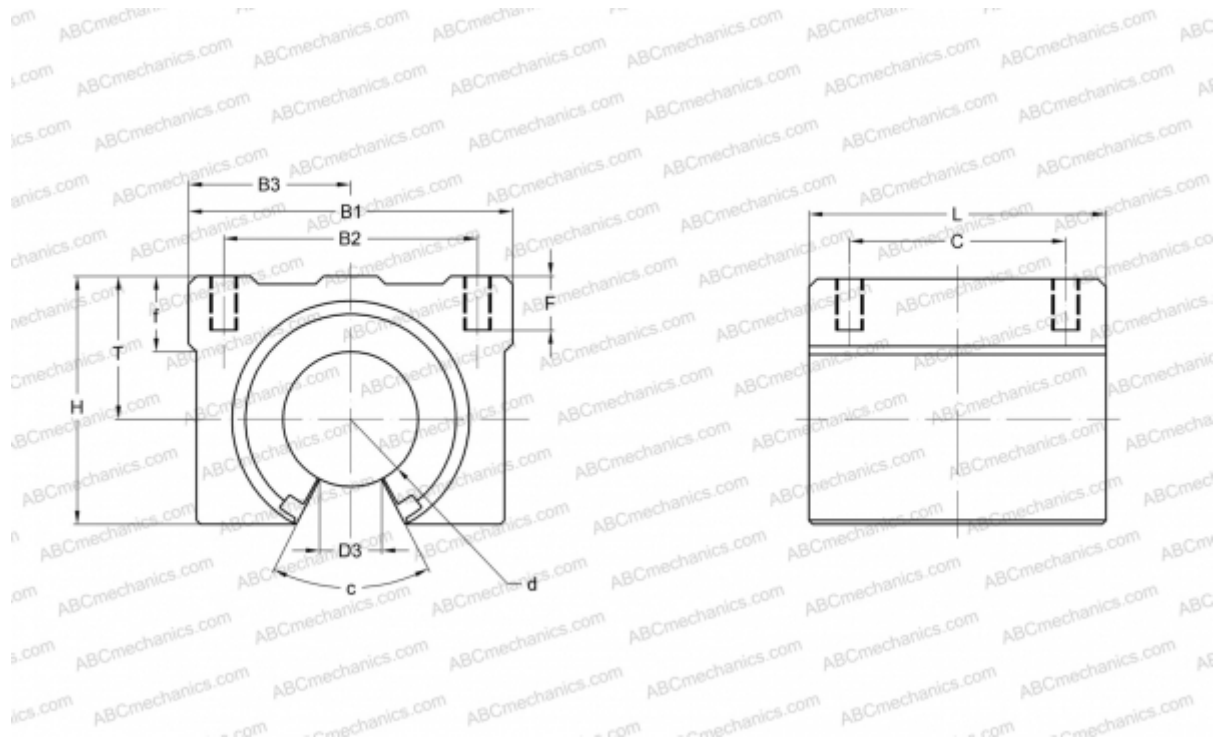

### Technical specification

#### DIMENSIONS, MM

B1	70,000
H	56,000
L	70,000
d	30,000
D3	14,000
B2	50,000
B3	35,000
T	33,000
f	15,000
C	50,000
c	50
F	18

**WEIGHT, KG** 0,630

**MANUFACTURER** [NB](#)