

SME40GUU NB

Linear bushing, case unit

TYPE: Shaft guidance systems, Linear bushing, case unit, Open type, Block type, Type SME, Standart (NB)

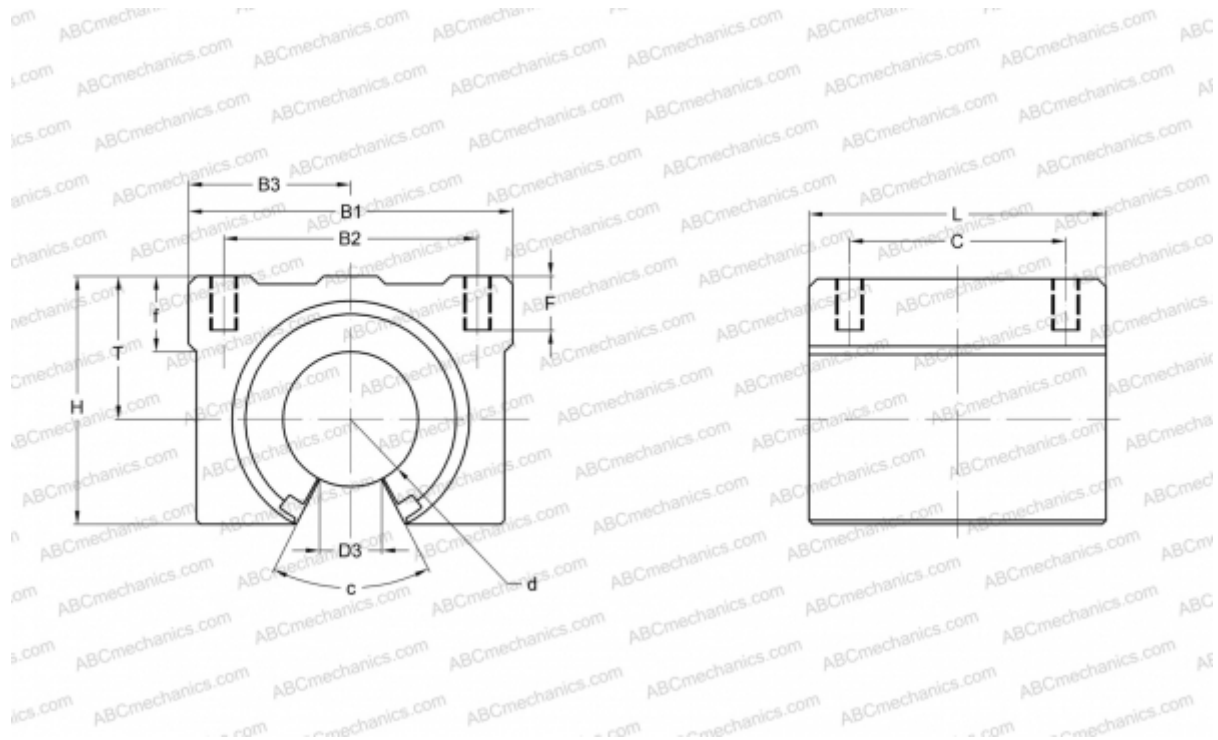

Technical specification

DIMENSIONS, MM

B1	90,000
H	72,000
L	90,000
d	40,000
D3	19,000
B2	65,000
B3	45,000
T	42,000
f	20,000
C	65,000
c	50
F	20

WEIGHT, KG 1,330

MANUFACTURER [NB](#)