

## SMSE16GUU NB

Linear bushing, case unit

TYPE: Shaft guidance systems, Linear bushing, case unit, Open type, Block type, Type SME, Corrosion resistance (NB)

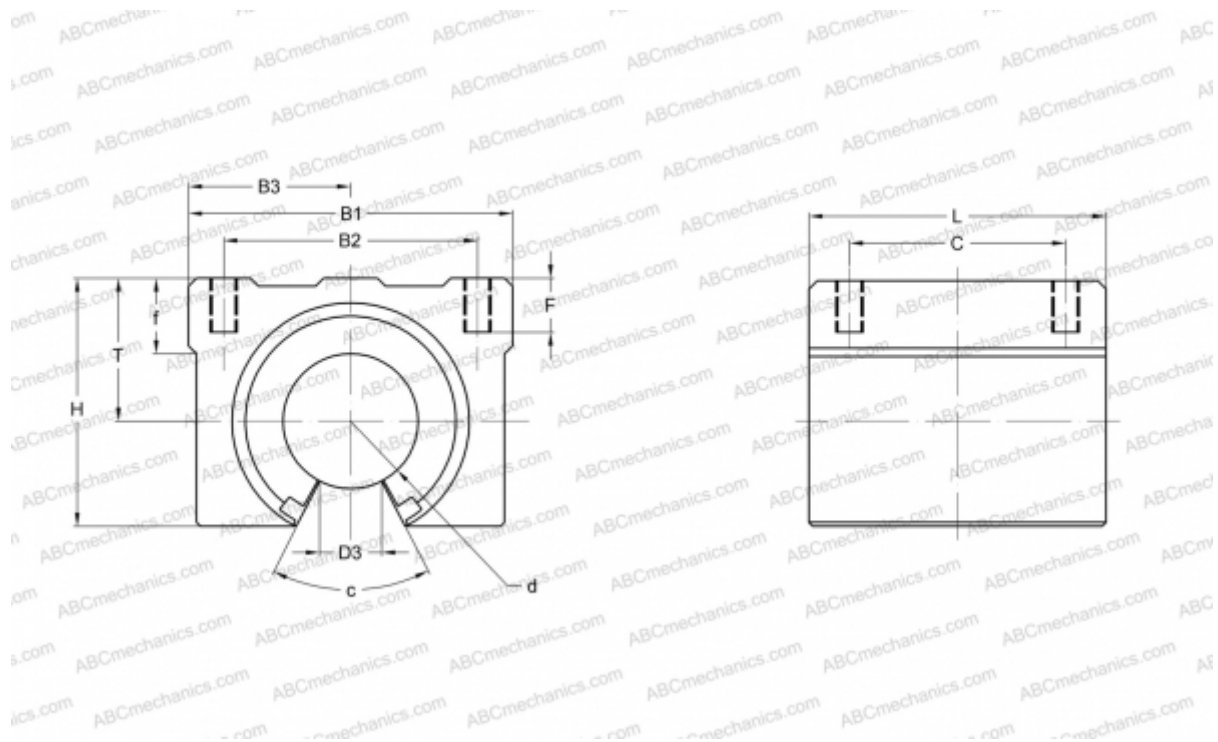

### Technical specification

#### DIMENSIONS, MM

B1	45,000
H	33,000
L	45,000
d	16,000
D3	10,000
B2	32,000
B3	22,500
T	20,000
f	9,000
C	30,000
c	80
F	12

**WEIGHT, KG** 0,150

**MANUFACTURER** [NB](#)