

SMSE25GUU NB

Linear bushing, case unit

TYPE: Shaft guidance systems, Linear bushing, case unit, Open type, Block type, Type SME, Corrosion resistance (NB)

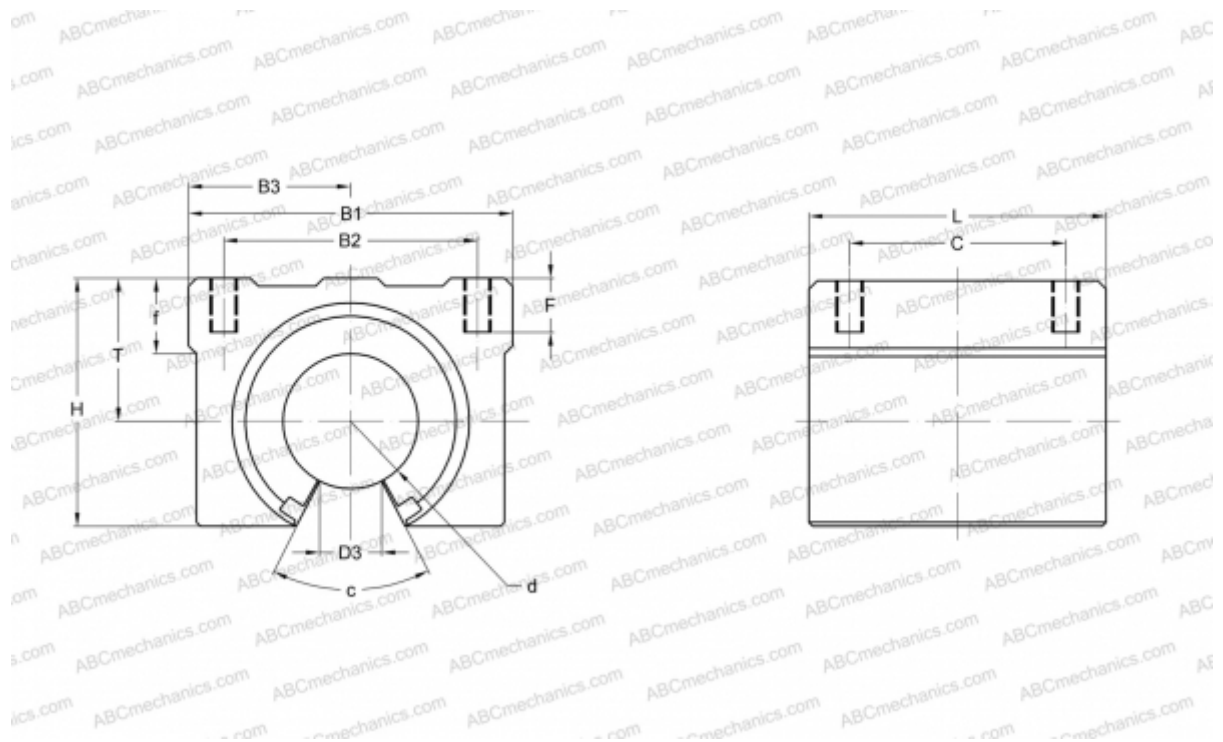

Technical specification

DIMENSIONS, MM

B1	60,000
H	47,000
L	65,000
d	25,000
D3	11,500
B2	40,000
B3	30,000
T	27,000
f	14,000
C	40,000
c	50
F	12

WEIGHT, KG 0,450

MANUFACTURER [NB](#)