

## SMSE35GUU NB

Linear bushing, case unit

TYPE: Shaft guidance systems, Linear bushing, case unit, Open type, Block type, Type SME, Corrosion resistance (NB)

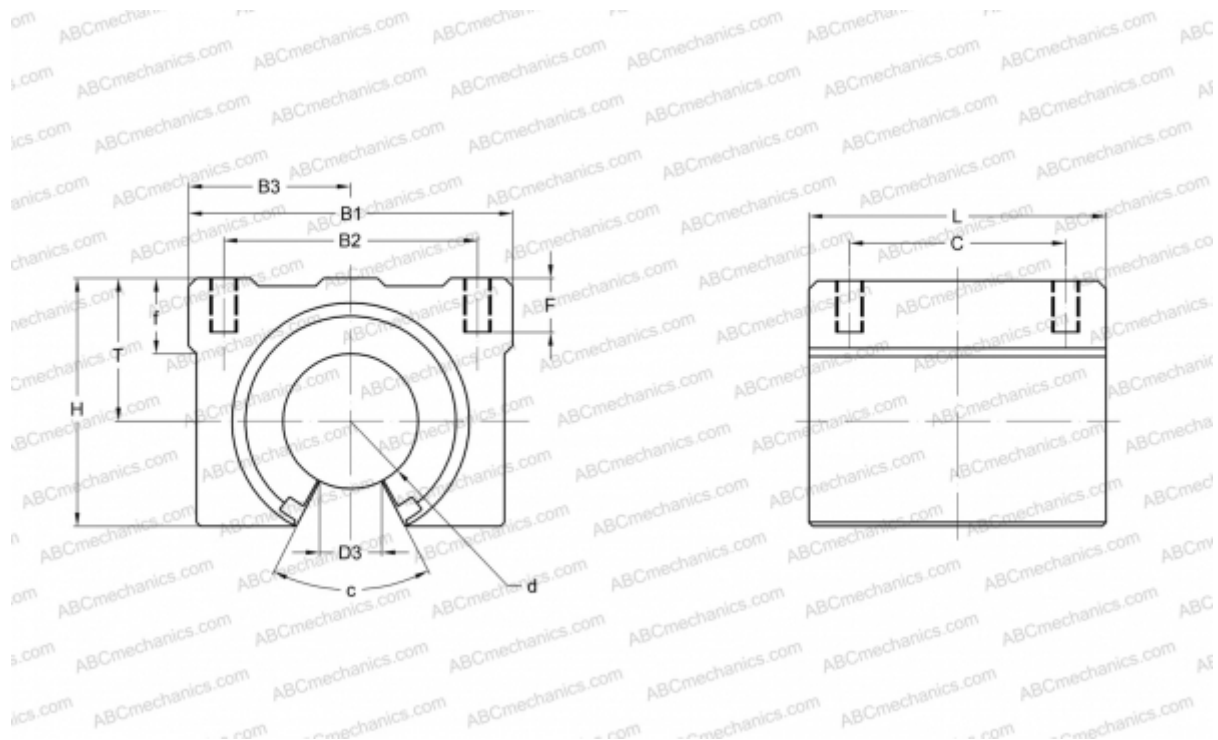

### Technical specification

#### DIMENSIONS, MM

B1	80,000
H	63,000
L	80,000
d	35,000
D3	16,000
B2	55,000
B3	40,000
T	37,000
f	18,000
C	55,000
c	50
F	18

**WEIGHT, KG** 0,925

**MANUFACTURER** [NB](#)