

SWD 8GUU NB

Linear bushing, case unit

TYPE: Shaft guidance systems, Linear bushing, case unit, Open type, Block type, Type SWD, inch size, Standart (NB)

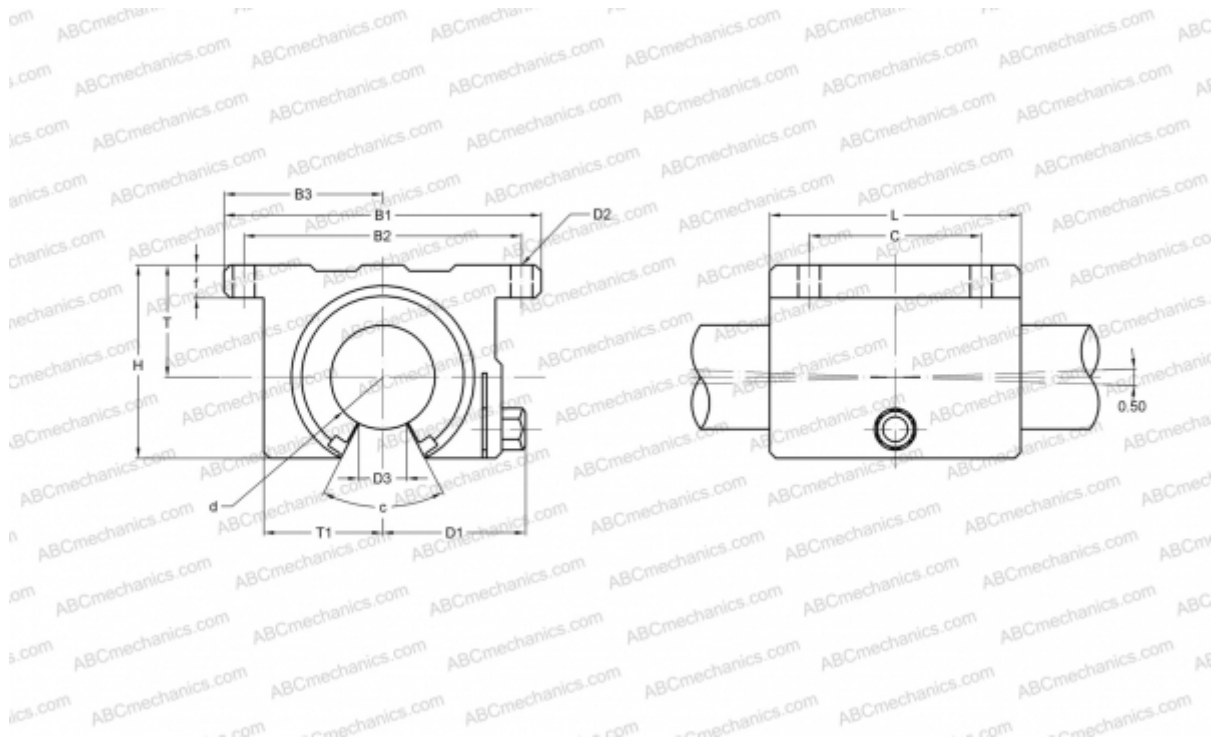

Technical specification

DIMENSIONS, MM

B1	50,800
H	27,940
L	38,100
d	12,700
D1	24,890
D3	8,700
B2	42,880
B3	25,400
T	17,450
T1	17,500
f	6,350
C	25,400
c	80

WEIGHT, KG 0,098

MANUFACTURER [NB](#)