

SWD 16GUU NB

Linear bushing, case unit

TYPE: Shaft guidance systems, Linear bushing, case unit, Open type, Block type, Type SWD, inch size, Standart (NB)

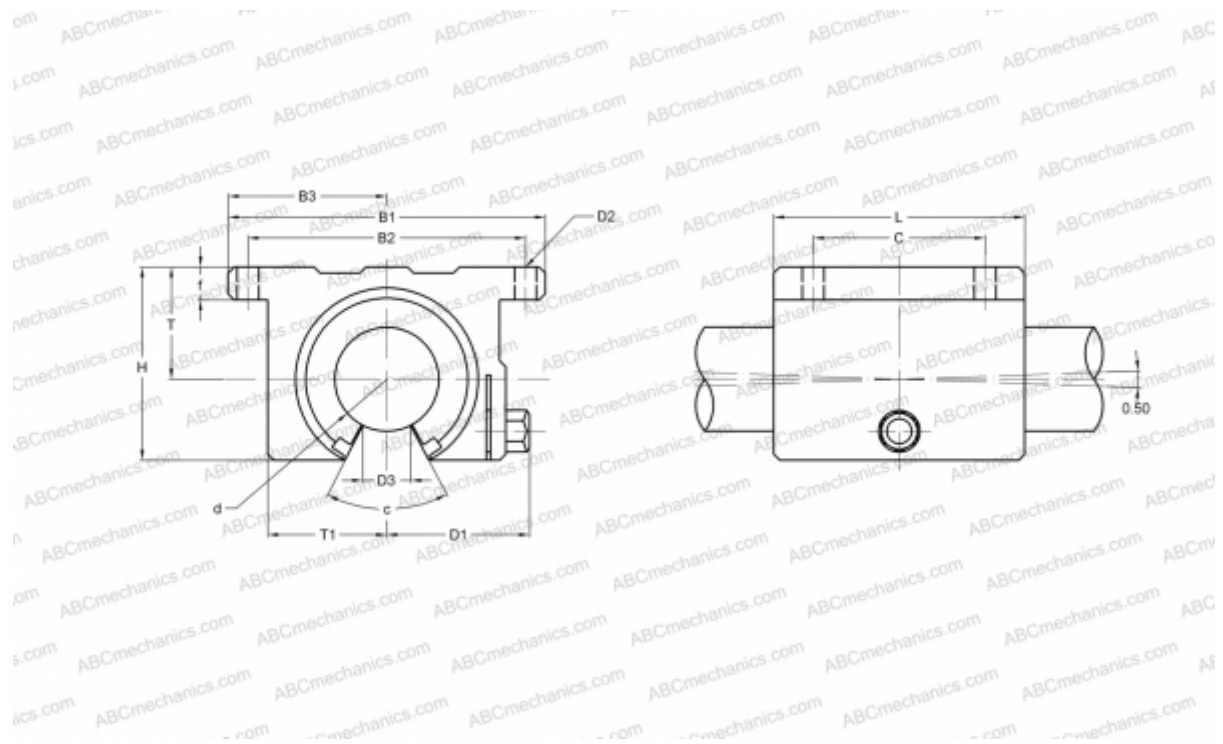

Technical specification

DIMENSIONS, MM

B1	82,550
H	50,170
L	66,680
d	25,400
D1	37,590
D3	14,290
B2	73,030
B3	41,300
T	30,150
T1	30,180
f	9,530
C	44,450
c	50

WEIGHT, KG 0,530

MANUFACTURER [NB](#)