

SWD 10GUU NB

Linear bushing, case unit

TYPE: Shaft guidance systems, Linear bushing, case unit, Open type, Block type, Type SWD, inch size, Corrosion resistance (NB)

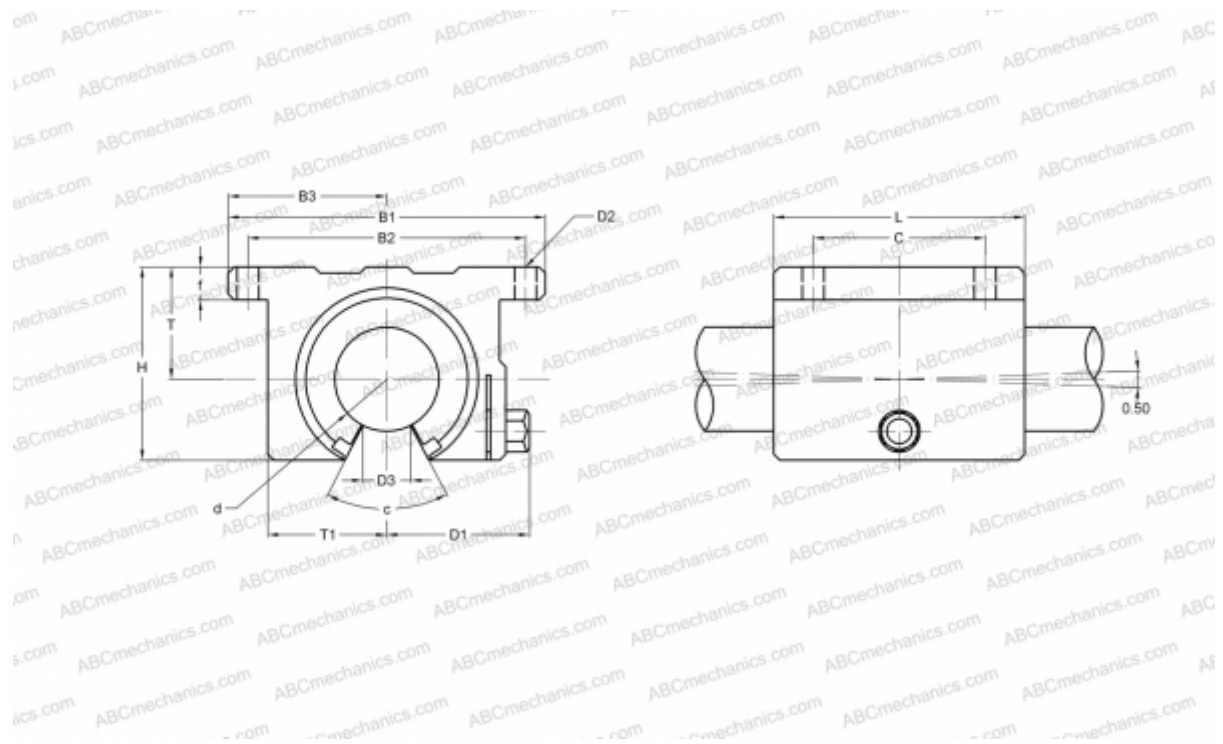

Technical specification

DIMENSIONS, MM

B1	63,500
H	34,930
L	44,450
d	15,875
D1	29,210
D3	9,530
B2	53,980
B3	31,750
T	22,225
T1	22,230
f	7,140
C	28,580
c	80

WEIGHT, KG 0,185

MANUFACTURER [NB](#)