

SWD 12GUU NB

Linear bushing, case unit

TYPE: Shaft guidance systems, Linear bushing, case unit, Open type, Block type, Type SWD, inch size, Corrosion resistance (NB)

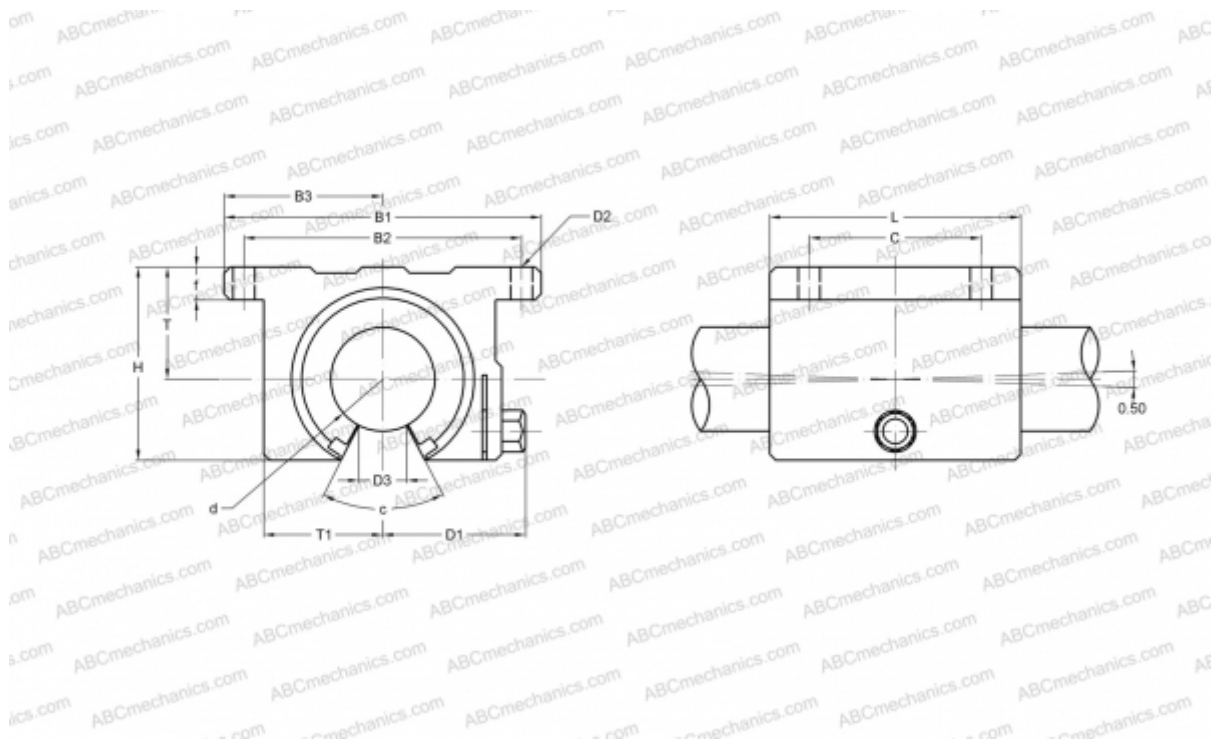

Technical specification

DIMENSIONS, MM

B1	69,850
H	39,000
L	47,630
d	19,050
D1	31,240
D3	11,110
B2	60,330
B3	34,950
T	23,800
T1	23,800
f	8,000
C	31,750
c	60

WEIGHT, KG 0,235

MANUFACTURER [NB](#)