

SWD 32GUU NB

Linear bushing, case unit

TYPE: Shaft guidance systems, Linear bushing, case unit, Open type, Block type, Type SWD, inch size, Corrosion resistance (NB)

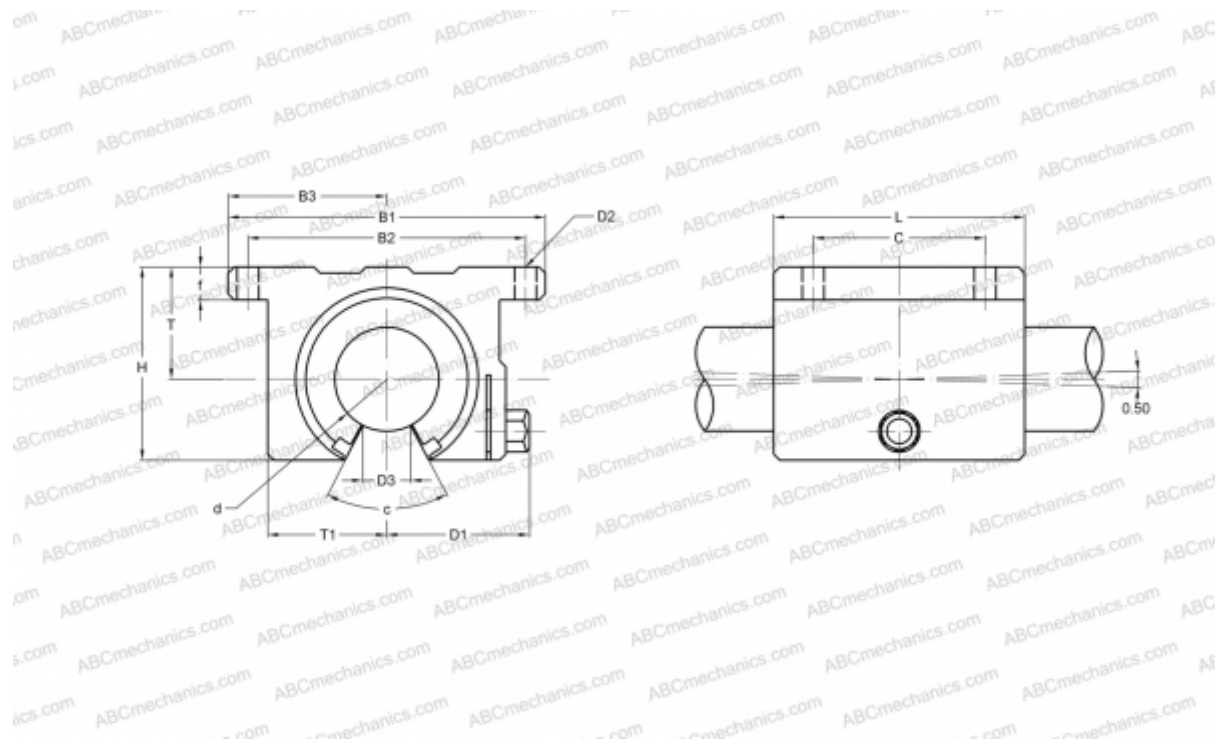

Technical specification

DIMENSIONS, MM

B1	152,400
H	92,900
L	120,650
d	50,800
D1	68,580
D3	25,400
B2	133,350
B3	76,200
T	53,975
T1	57,150
f	15,880
C	82,550
c	50

WEIGHT, KG 3,100

MANUFACTURER [NB](#)