

SME13GWUU NB

Linear bushing, case unit

TYPE: Shaft guidance systems, Linear bushing, case unit, Open type, Double-wide block type, Type SME..W, Standart (NB)

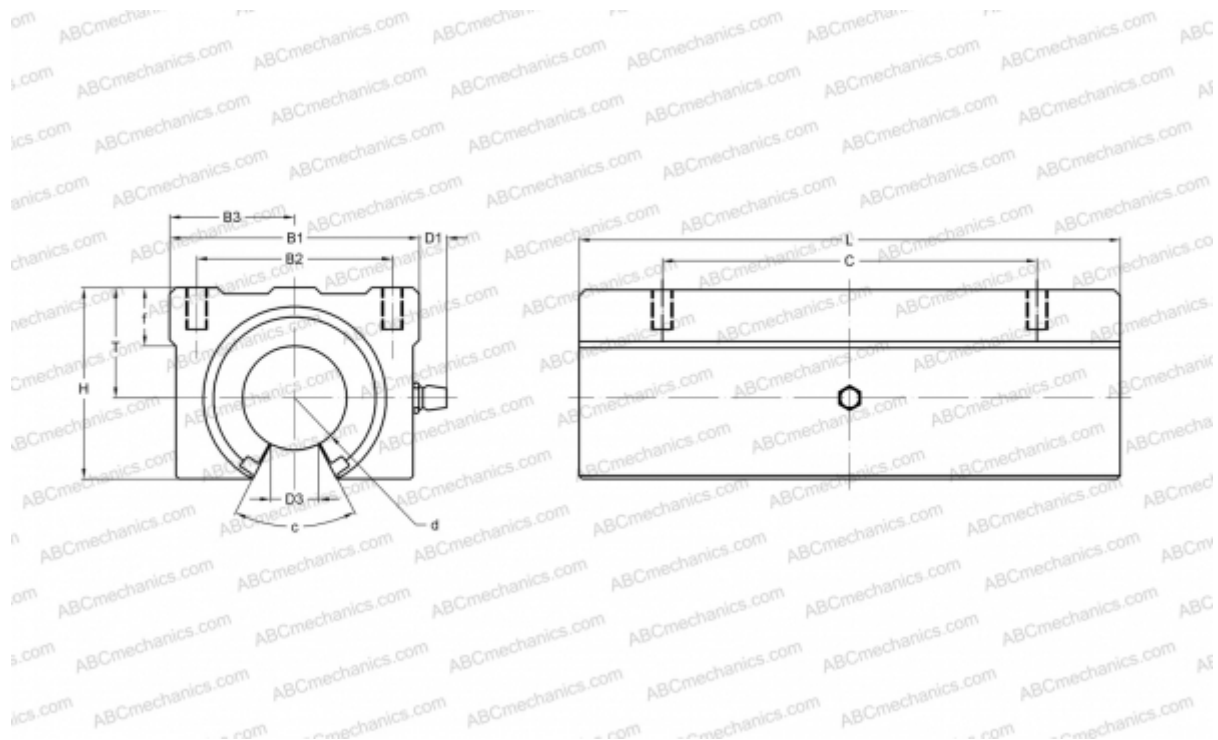

Technical specification

DIMENSIONS, MM

B1	40,000
H	28,000
L	75,000
d	13,000
D1	7,500
D3	8,500
B2	28,000
B3	20,000
T	17,000
f	8,000
C	50,000
c	80

WEIGHT, KG 0,200

MANUFACTURER [NB](#)